

ONE BED + DEN

HAMBURG

590 SQ.FT. • 77 SQ.FT. BALCONY

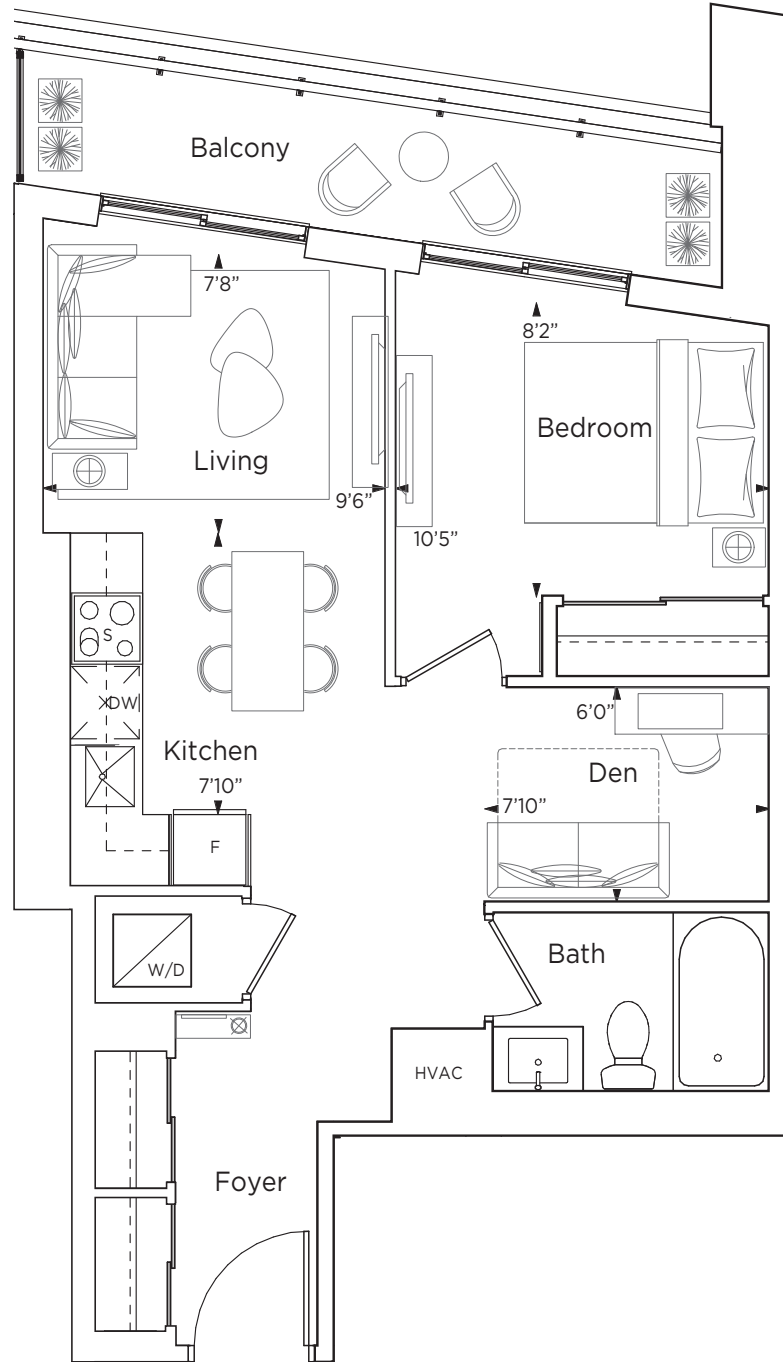

B1

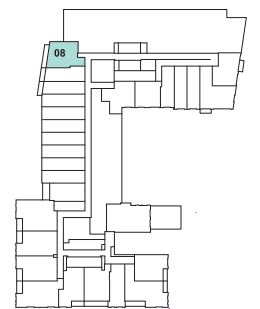

Tower A
LEVEL 2



Vincent
CONDOMINIUMS



Materials, specifications and floor plans are subject to change. All renderings are artist's concept. All floor plans are approximate dimensions. Actual usable floor space may vary from stated floor area. Balcony/terrace areas may vary. Windows, room/area dimensions & square feet may vary due to location within building. Furniture not included. E. & O. E.

STUDIO

BANGKOK

400 SQ.FT. • 45 SQ.FT. BALCONY

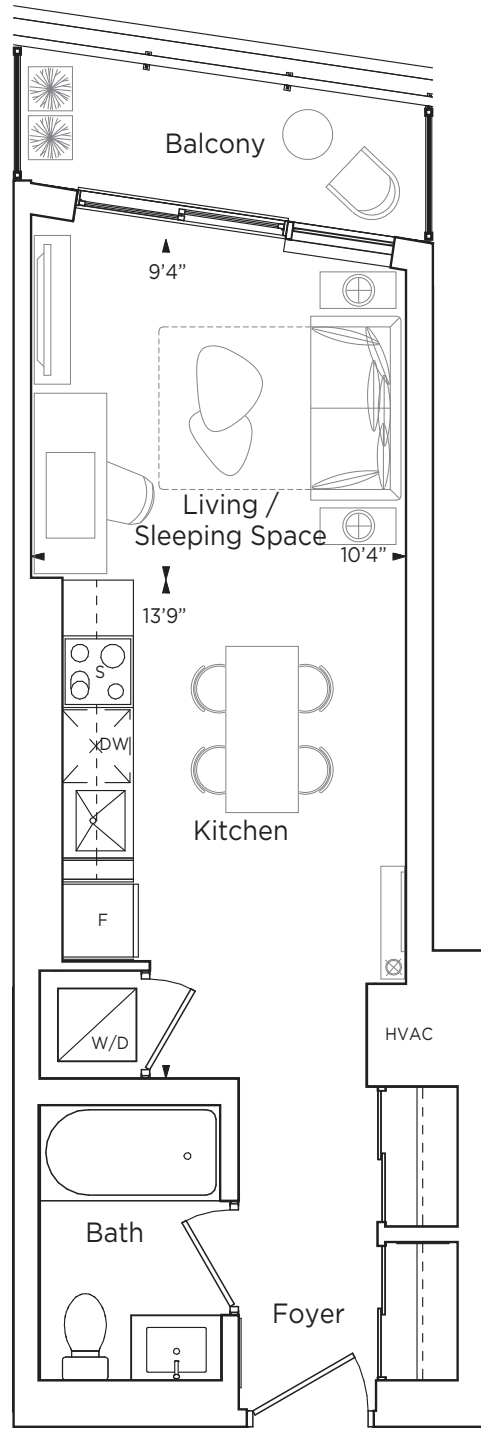

B2

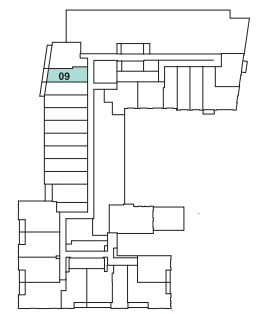

Tower A
LEVEL 2



Vincent
CONDOMINIUMS



Materials, specifications and floor plans are subject to change. All renderings are artist's concept. All floor plans are approximate dimensions. Actual usable floor space may vary from stated floor area. Balcony/terrace areas may vary. Windows, room/area dimensions & square feet may vary due to location within building. Furniture not included. E. & O. E.

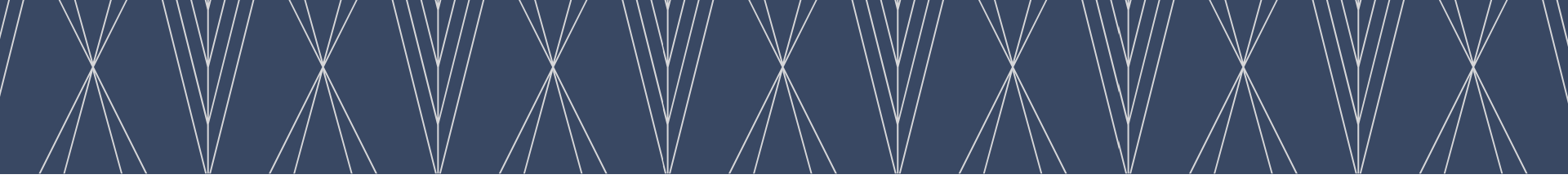

STUDIO
BACCARAT
 390 SQ.FT.

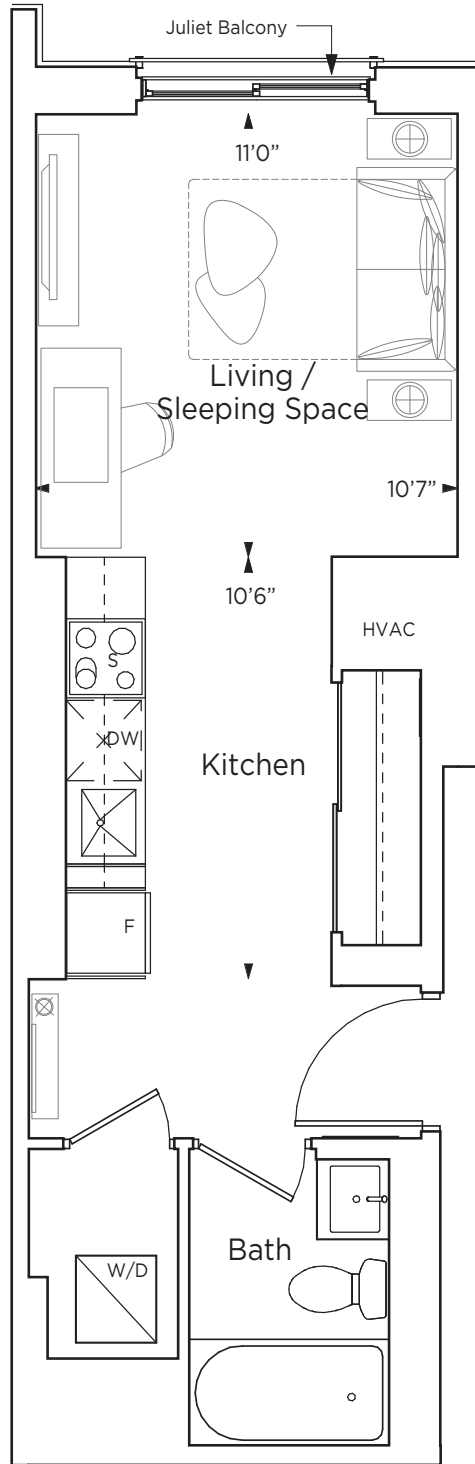

B3

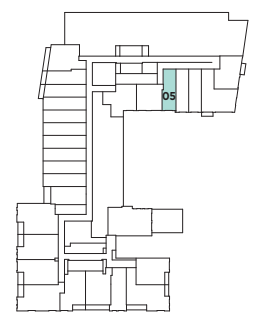

**Tower A
 LEVEL 2**



Materials, specifications and floor plans are subject to change. All renderings are artist's concept. All floor plans are approximate dimensions. Actual usable floor space may vary from stated floor area. Balcony/terrace areas may vary. Windows, room/area dimensions & square feet may vary due to location within building. Furniture not included. E. & O. E.

STUDIO

ASTON

388 SQ.FT. B4, B4-1 TO B4-5 • 401 SQ.FT. B4-6 • 377 SQ.FT. B4-7

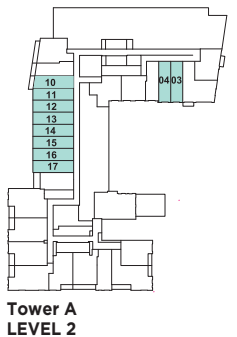
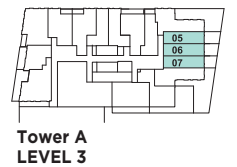
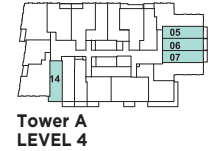
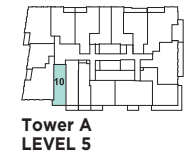
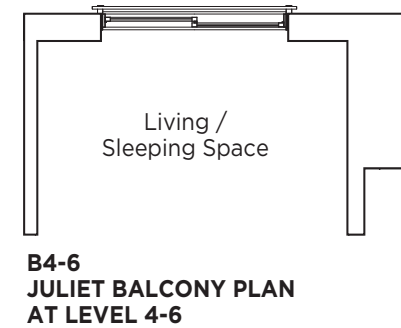
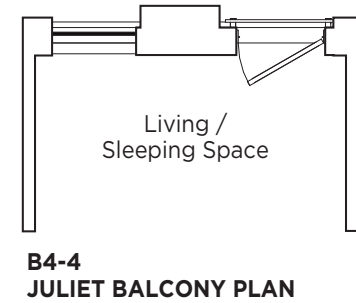
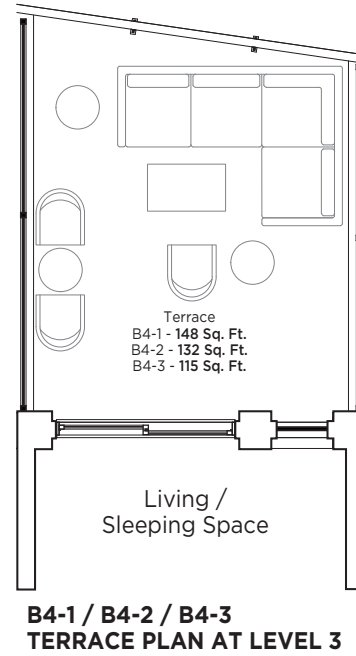
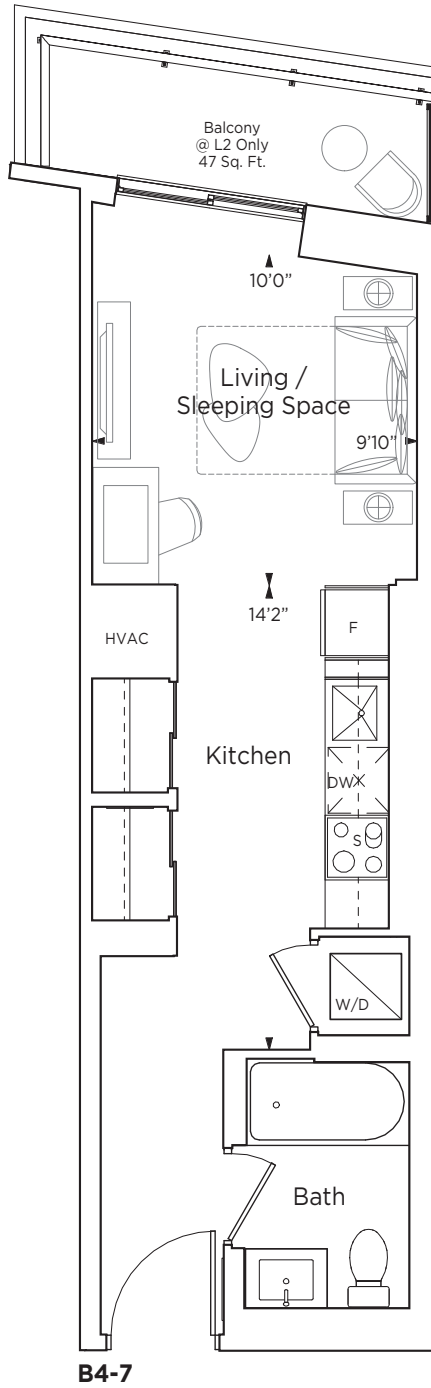
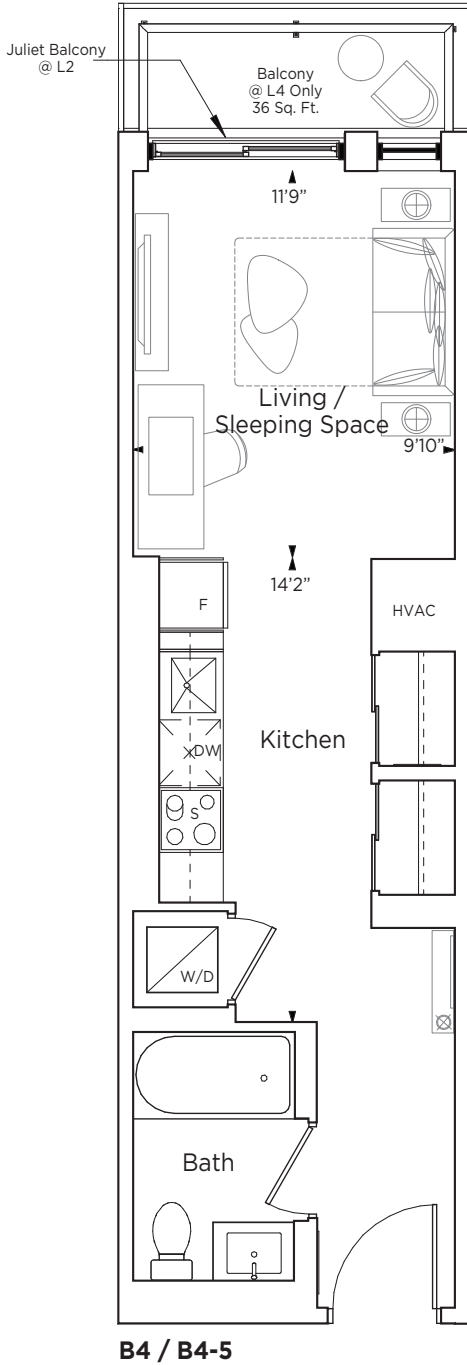

Vincent
CONDOMINIUMS



Materials, specifications and floor plans are subject to change. All renderings are artist's concept. All floor plans are approximate dimensions. Actual usable floor space may vary from stated floor area. Balcony/terrace areas may vary. Windows, room/area dimensions & square feet may vary due to location within building. Furniture not included. E. & O. E.

ONE BED + DEN

GENEVA

580 SQ.FT.

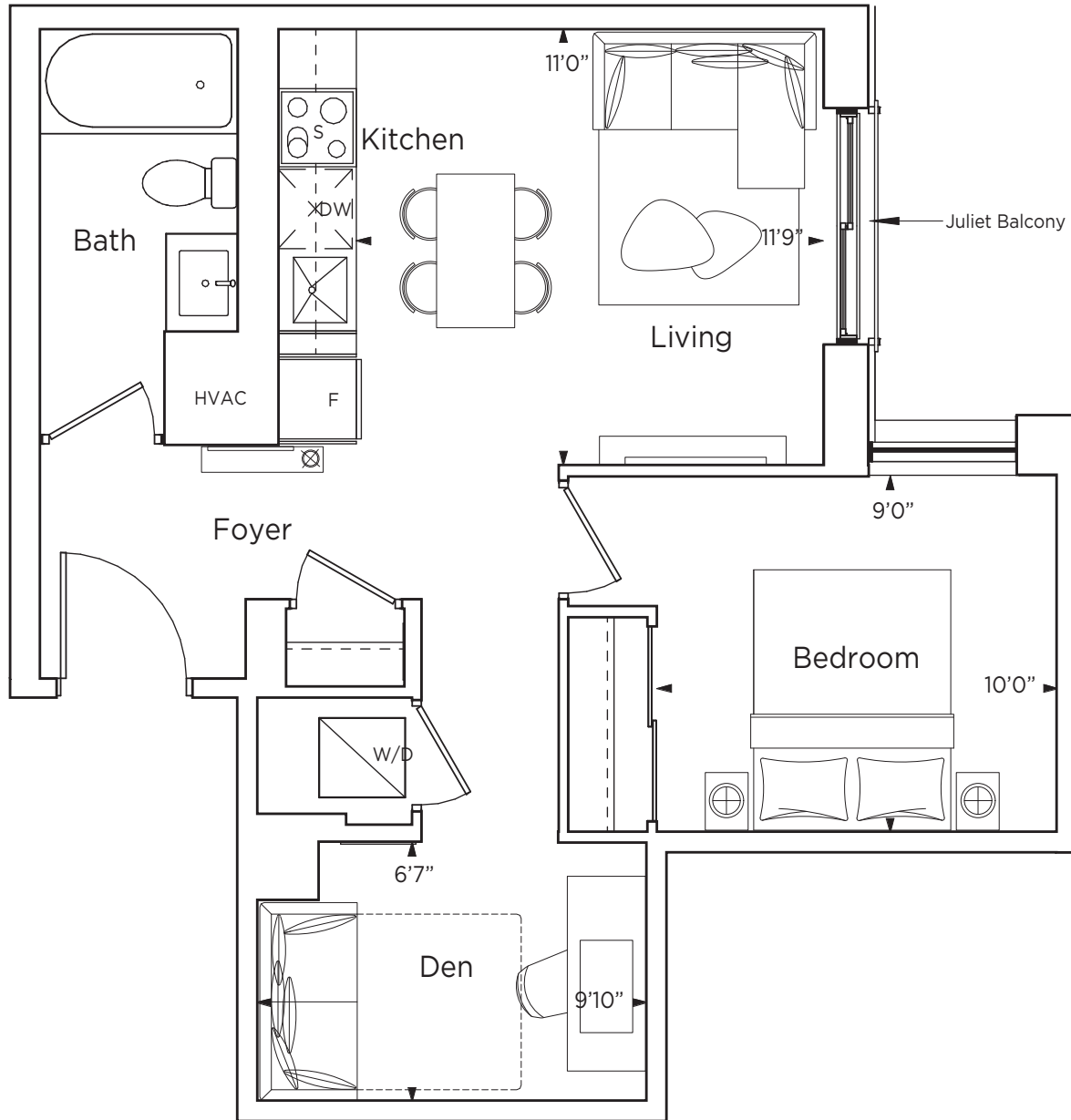

B24

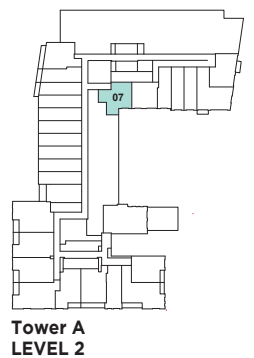

Materials, specifications and floor plans are subject to change. All renderings are artist's concept. All floor plans are approximate dimensions. Actual usable floor space may vary from stated floor area. Balcony/terrace areas may vary. Windows, room/area dimensions & square feet may vary due to location within building. Furniture not included. E. & O. E.

TWO BED

OXFORD

746 SQ.FT. • 33 SQ.FT. BALCONY

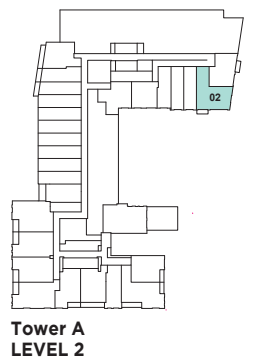
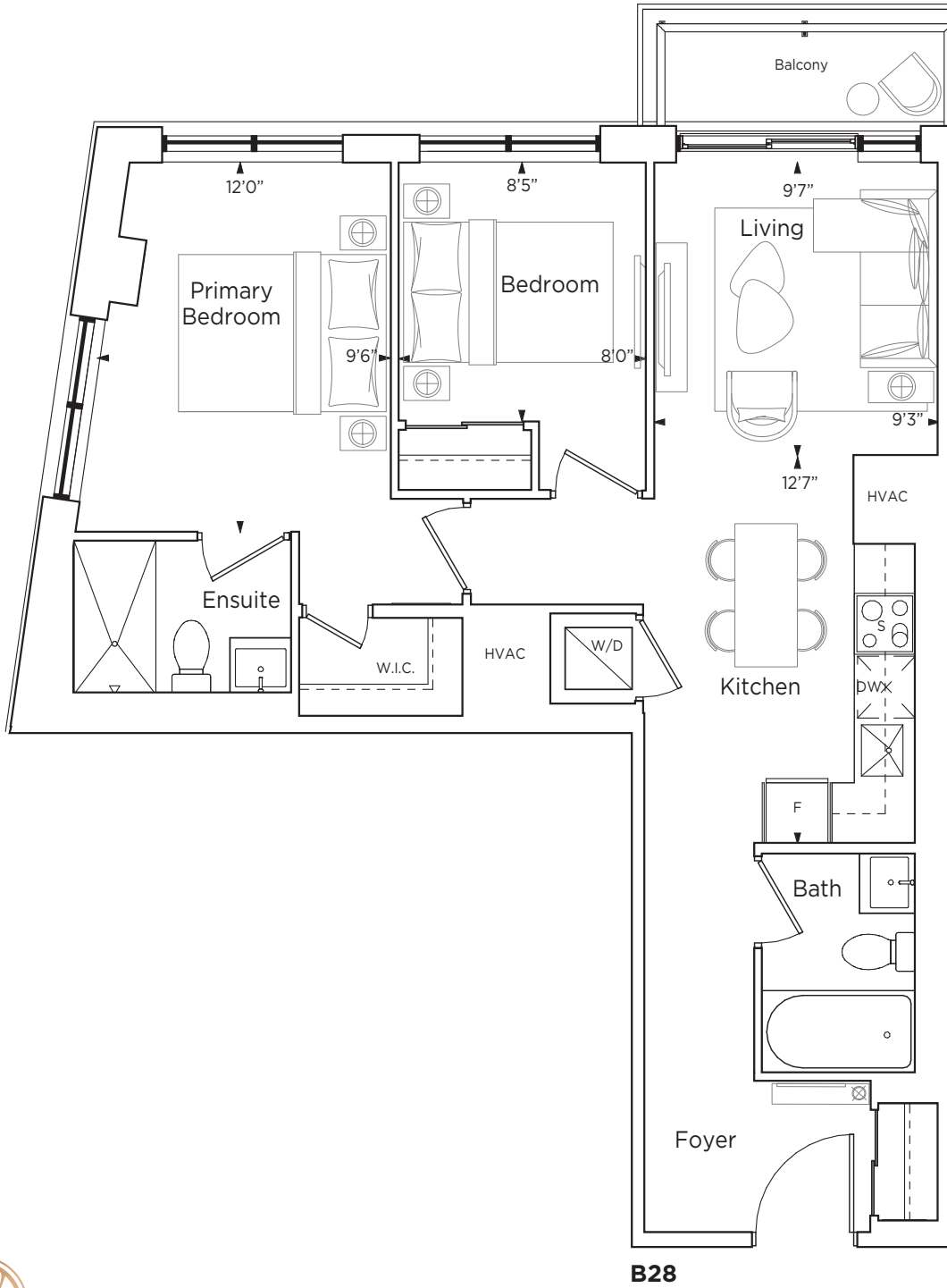

Materials, specifications and floor plans are subject to change. All renderings are artist's concept. All floor plans are approximate dimensions. Actual usable floor space may vary from stated floor area. Balcony/terrace areas may vary. Windows, room/area dimensions & square feet may vary due to location within building. Furniture not included. E. & O. E.

ONE BED + DEN

DELACROIX

557 SQ.FT. • 35 SQ.FT. BALCONY

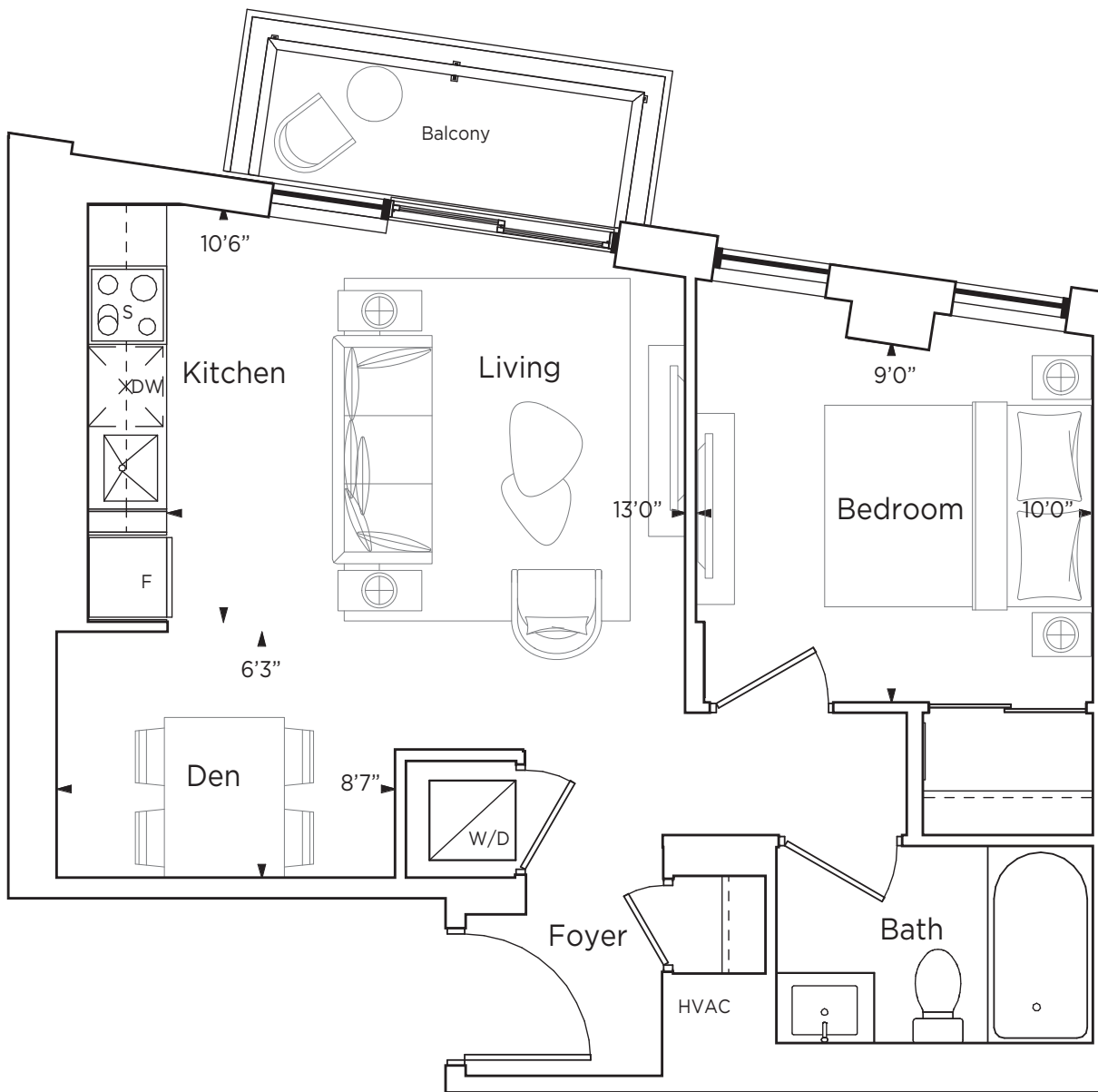

B29

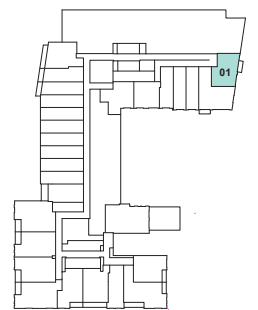

Tower A
LEVEL 2



Materials, specifications and floor plans are subject to change. All renderings are artist's concept. All floor plans are approximate dimensions. Actual usable floor space may vary from stated floor area. Balcony/terrace areas may vary. Windows, room/area dimensions & square feet may vary due to location within building. Furniture not included. E. & O. E.

STUDIO (BARRIER-FREE)

BELGRADE

433 SQ.FT. C1-1 • 443 SQ.FT. C1-2

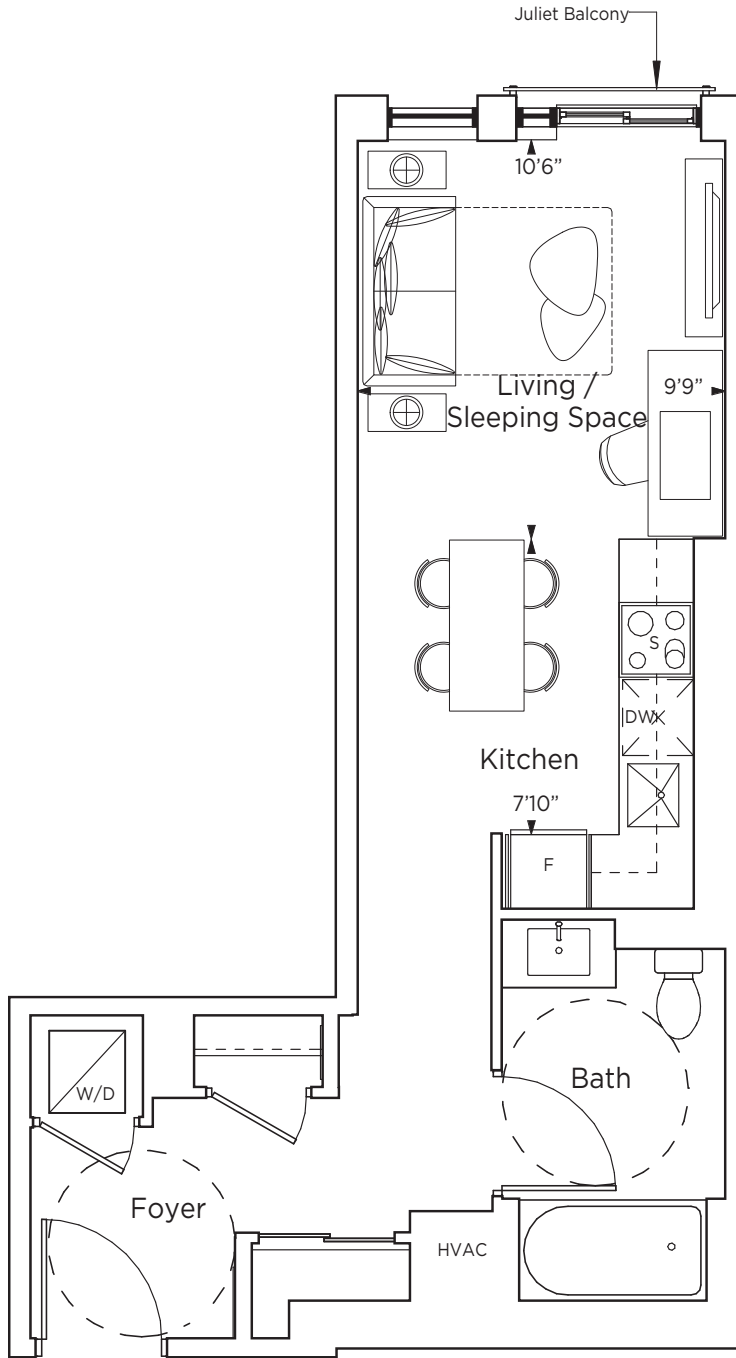

C1 - 1

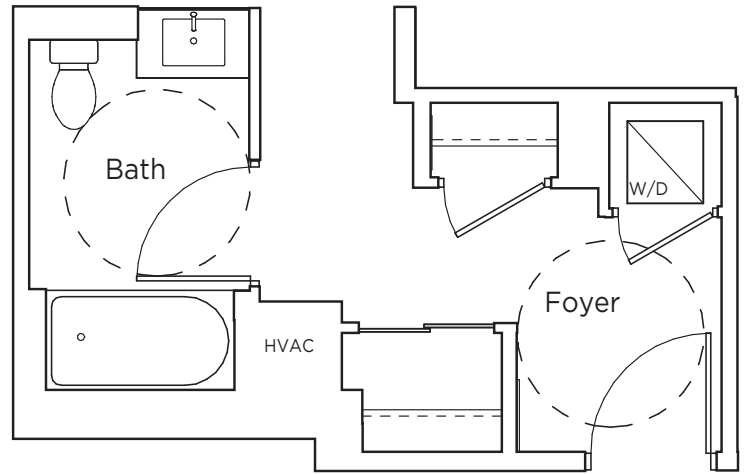

C1 - 2

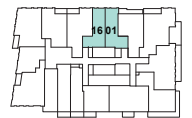

Tower A
LEVEL 5



Tower A
LEVEL 4

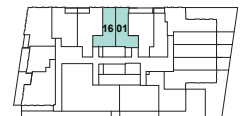

Tower A
LEVEL 3



Vincent
CONDOMINIUMS



ONE BED + DEN (BARRIER-FREE)

LAS VEGAS

655 SQ.FT. • 44 SQ.FT. BALCONY / TERRACE

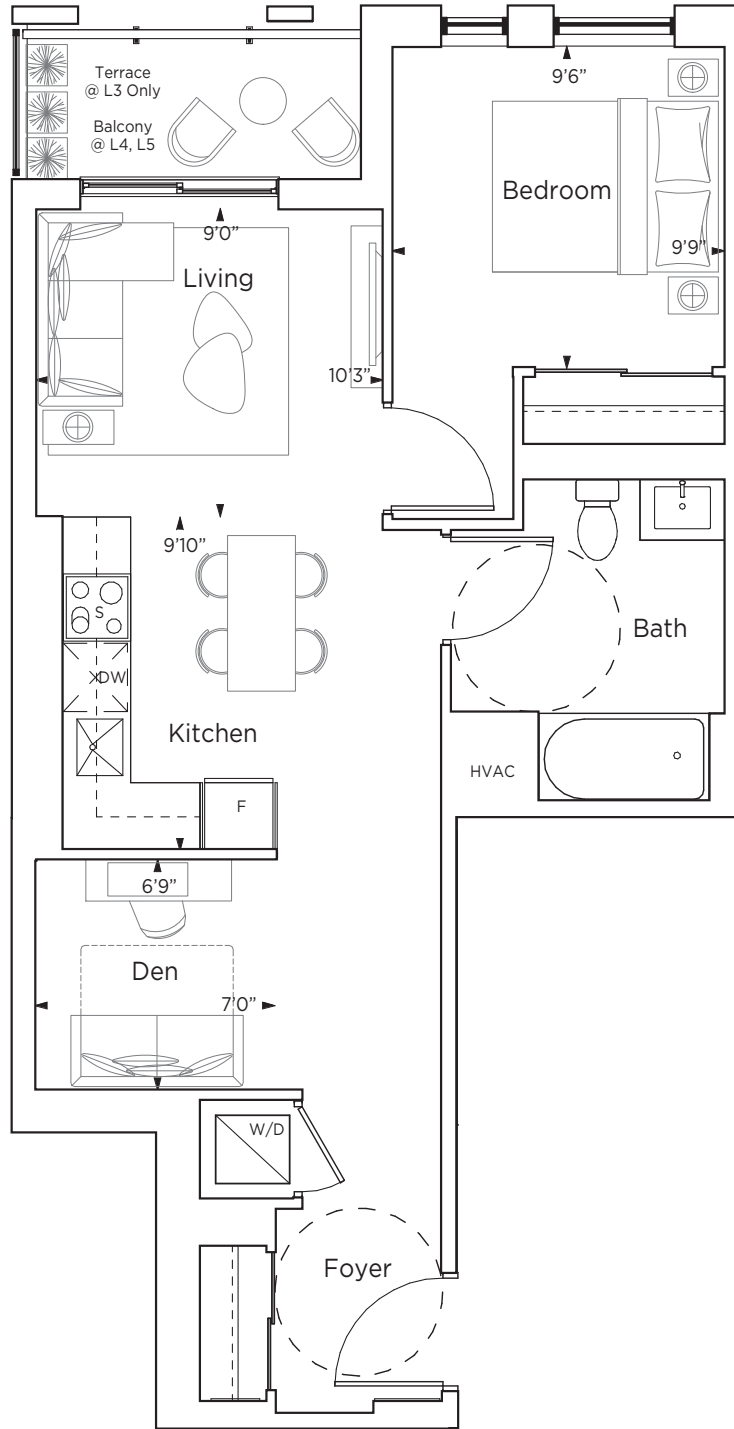

C2

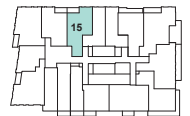

Tower A
LEVEL 5

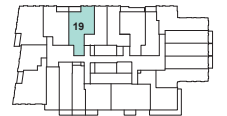

Tower A
LEVEL 4

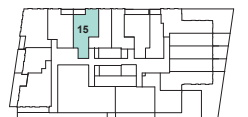

Tower A
LEVEL 3



Vincent
CONDOMINIUMS



Materials, specifications and floor plans are subject to change. All renderings are artist's concept. All floor plans are approximate dimensions. Actual usable floor space may vary from stated floor area. Balcony/terrace areas may vary. Windows, room/area dimensions & square feet may vary due to location within building. Furniture not included. E. & O. E.

ONE BED + DEN (BARRIER-FREE)

JACQUARD

600 SQ.FT. • 44 SQ.FT. BALCONY / TERRACE

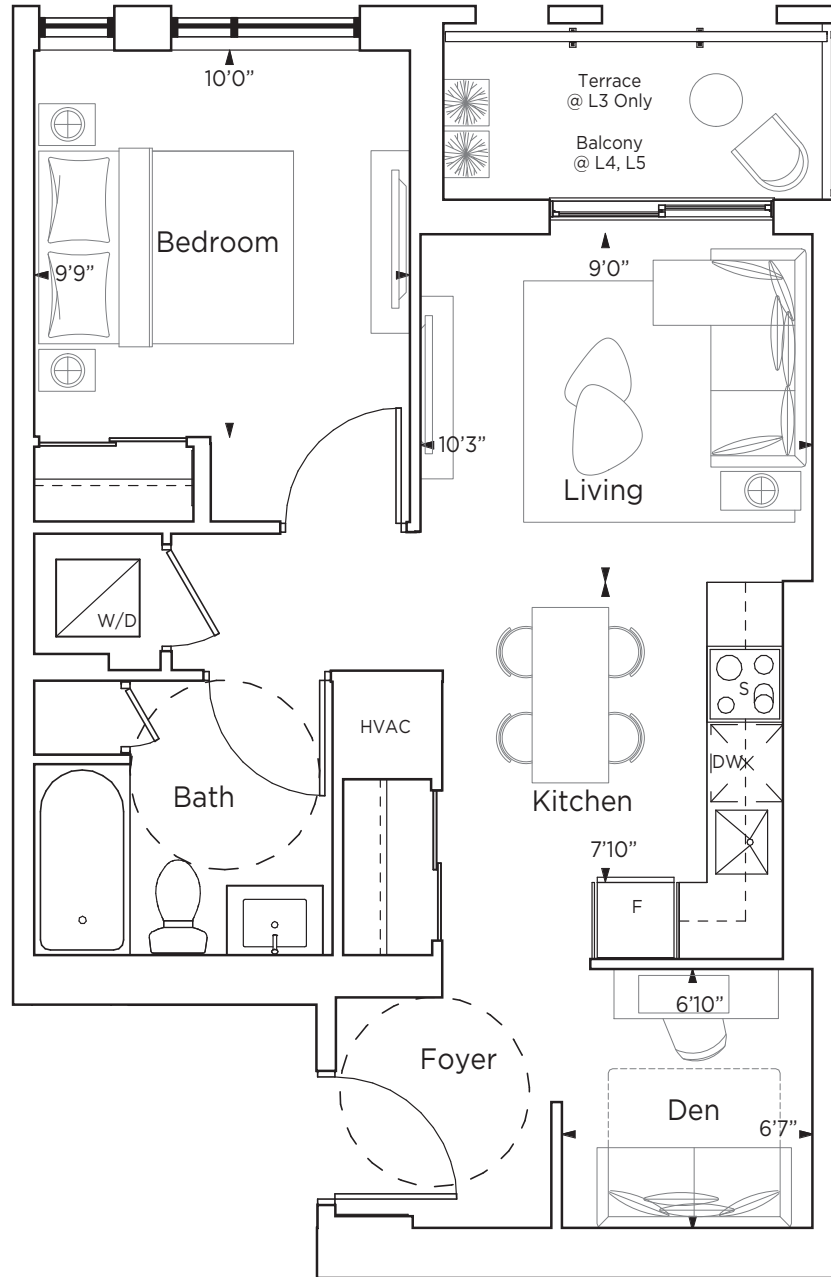

C3



Tower A
LEVEL 5



Tower A
LEVEL 4



Tower A
LEVEL 3



Vincent
CONDOMINIUMS



TWO BED

MONOGRAM

707 SQ.FT. • 47 SQ.FT. BALCONY / TERRACE

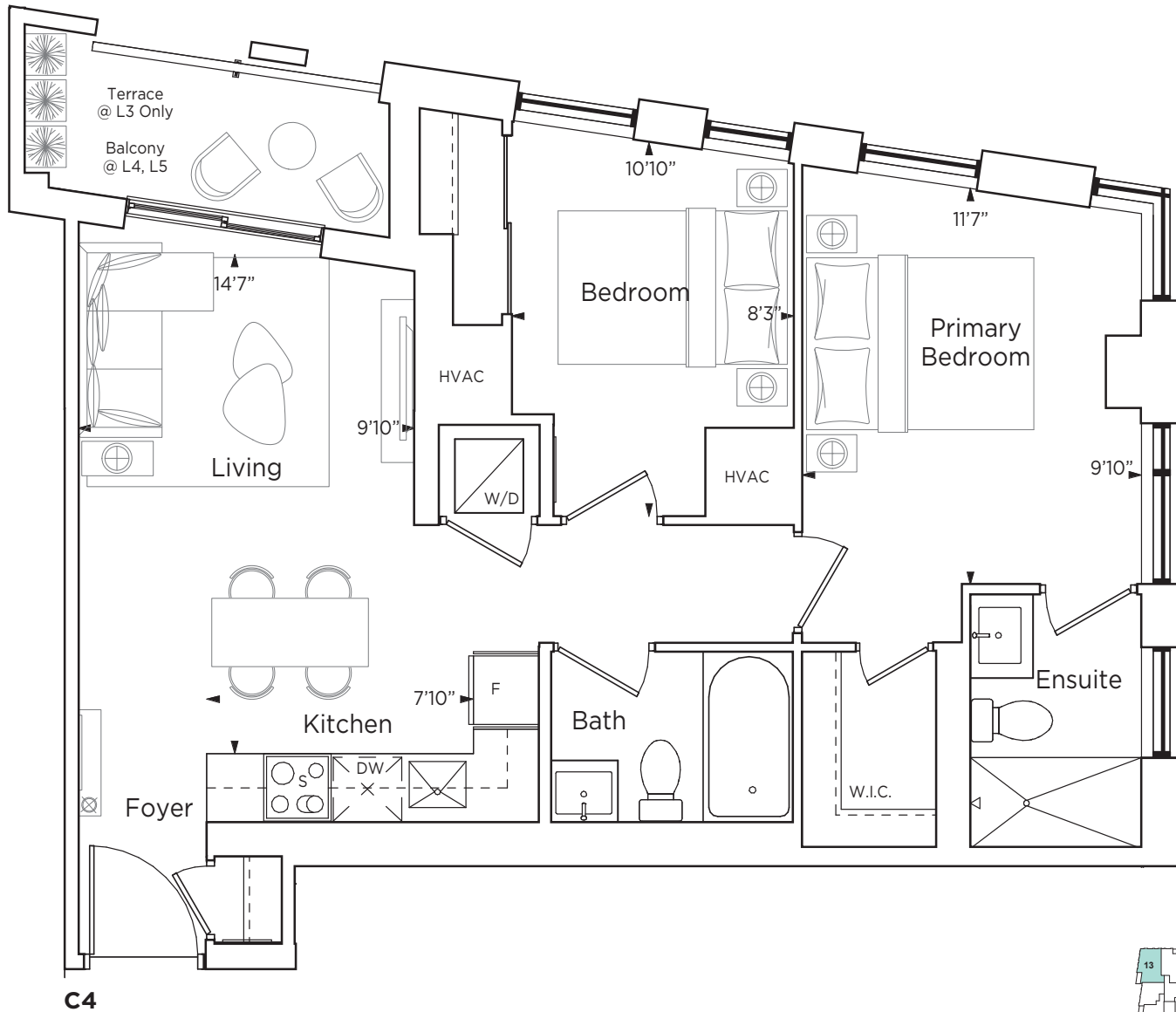

**Tower A
LEVEL 5**



**Tower A
LEVEL 4**



**Tower A
LEVEL 3**



Vincent
CONDOMINIUMS



ONE BED

BARCHETTA

432 SQ.FT. • 129 SQ.FT. TERRACE

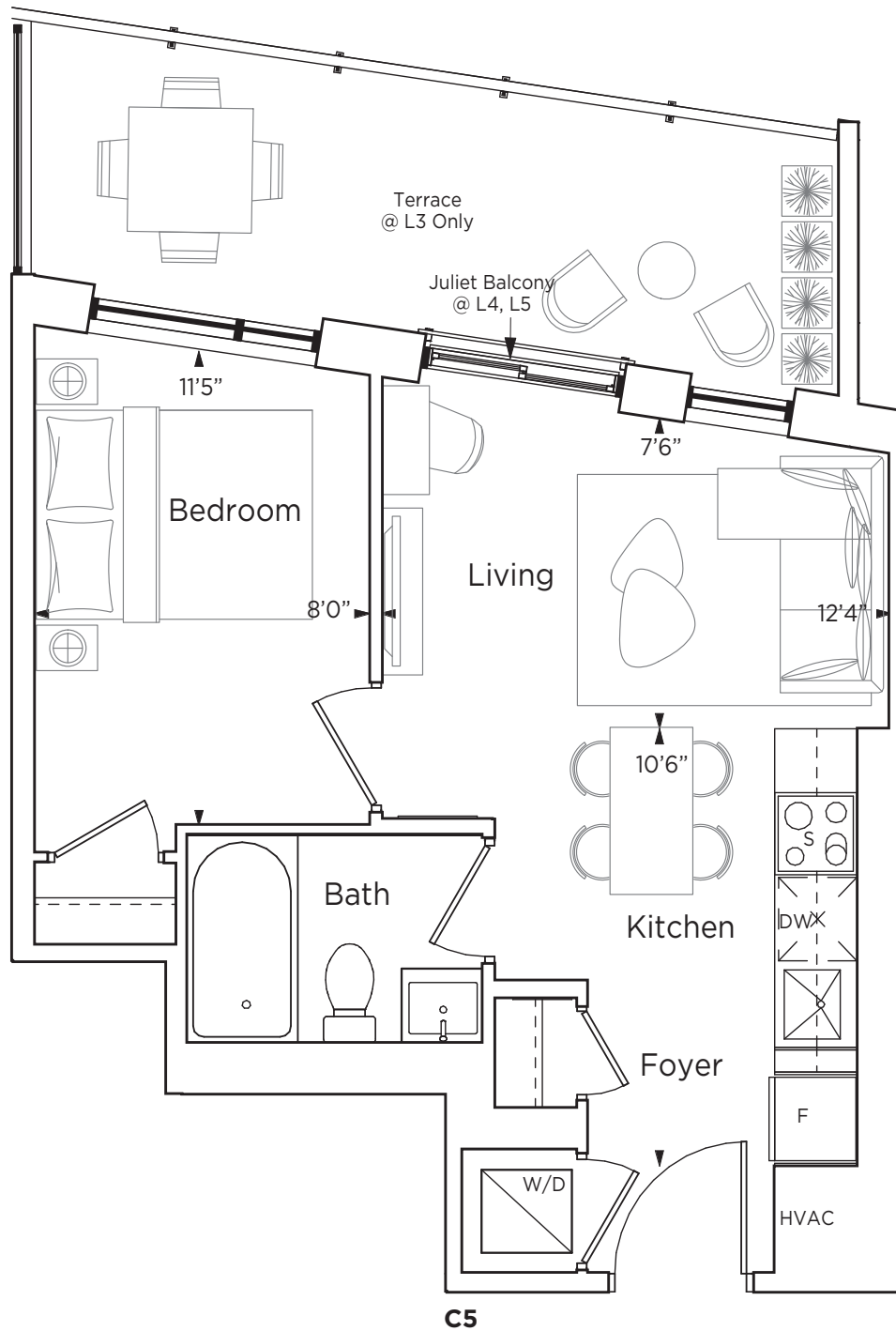

Tower A
LEVEL 5



Tower A
LEVEL 4



Tower A
LEVEL 3



Vincent
CONDOMINIUMS



TWO BED

MONTE CARLO

725 SQ. FT.

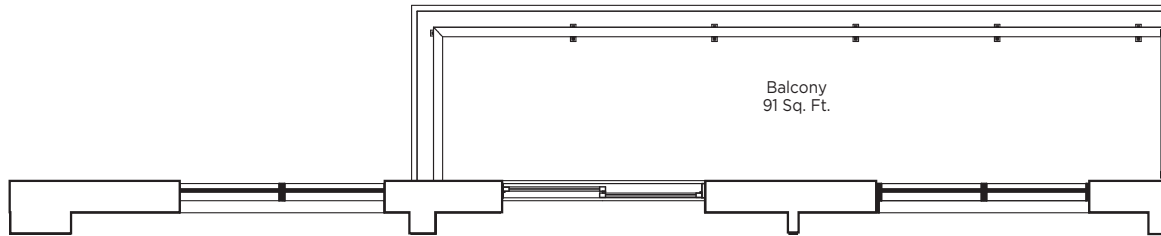

BALCONY PLAN AT LEVEL 35-37

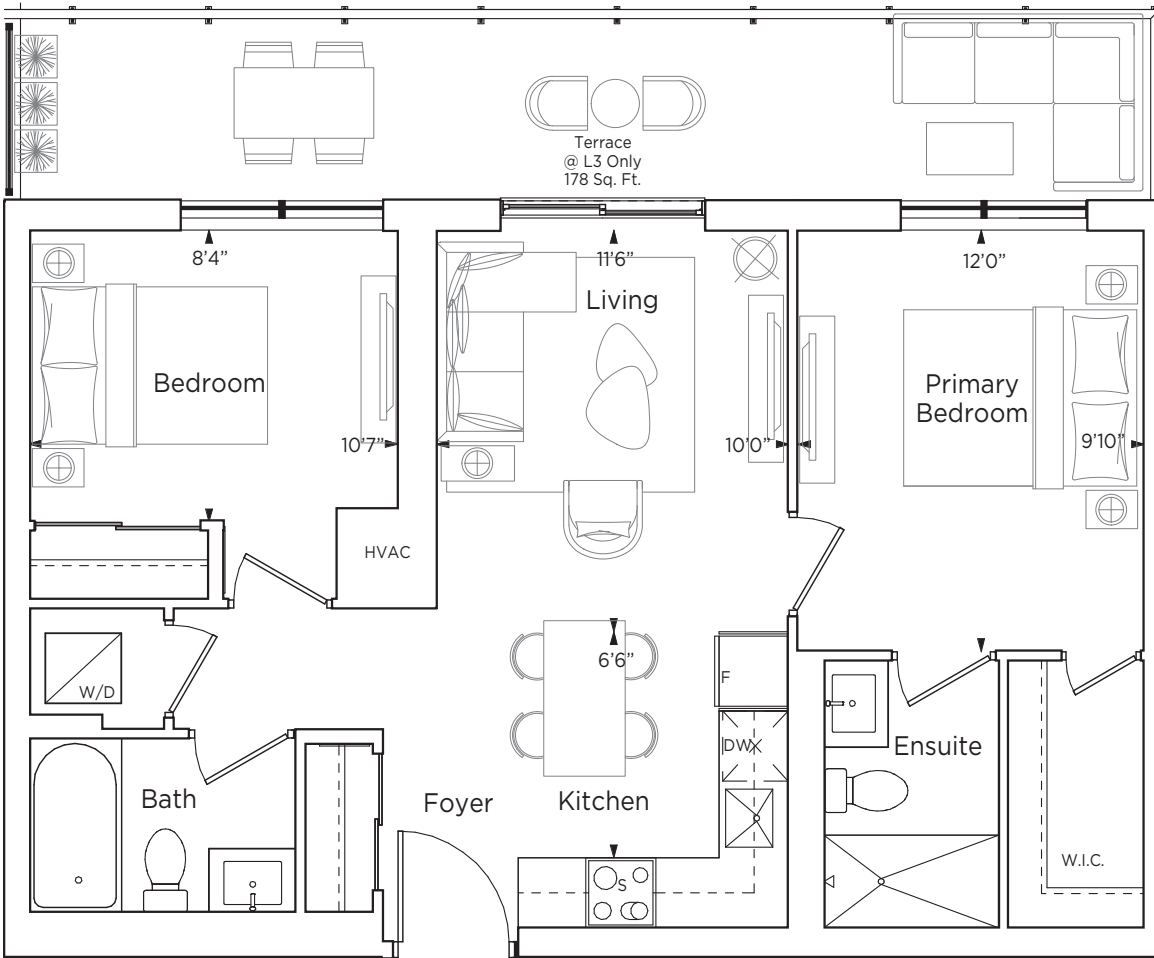

C7

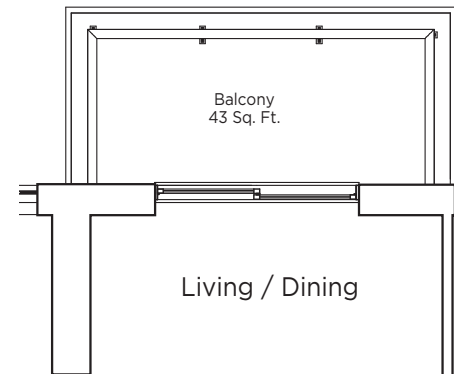

BALCONY PLAN AT LEVEL 4, 5, 6



**Tower A
LEVEL 35-37**



**Tower A
LEVEL 6**



**Tower A
LEVEL 5**



**Tower A
LEVEL 4**



**Tower A
LEVEL 3**



Vincent
CONDOMINIUMS



Materials, specifications and floor plans are subject to change. All renderings are artist's concept. All floor plans are approximate dimensions. Actual usable floor space may vary from stated floor area. Balcony/terrace areas may vary. Windows, room/area dimensions & square feet may vary due to location within building. Furniture not included. E. & O. E.

ONE BED + DEN

DIAMOND

557 SQ.FT. • 647 SQ.FT. TERRACE

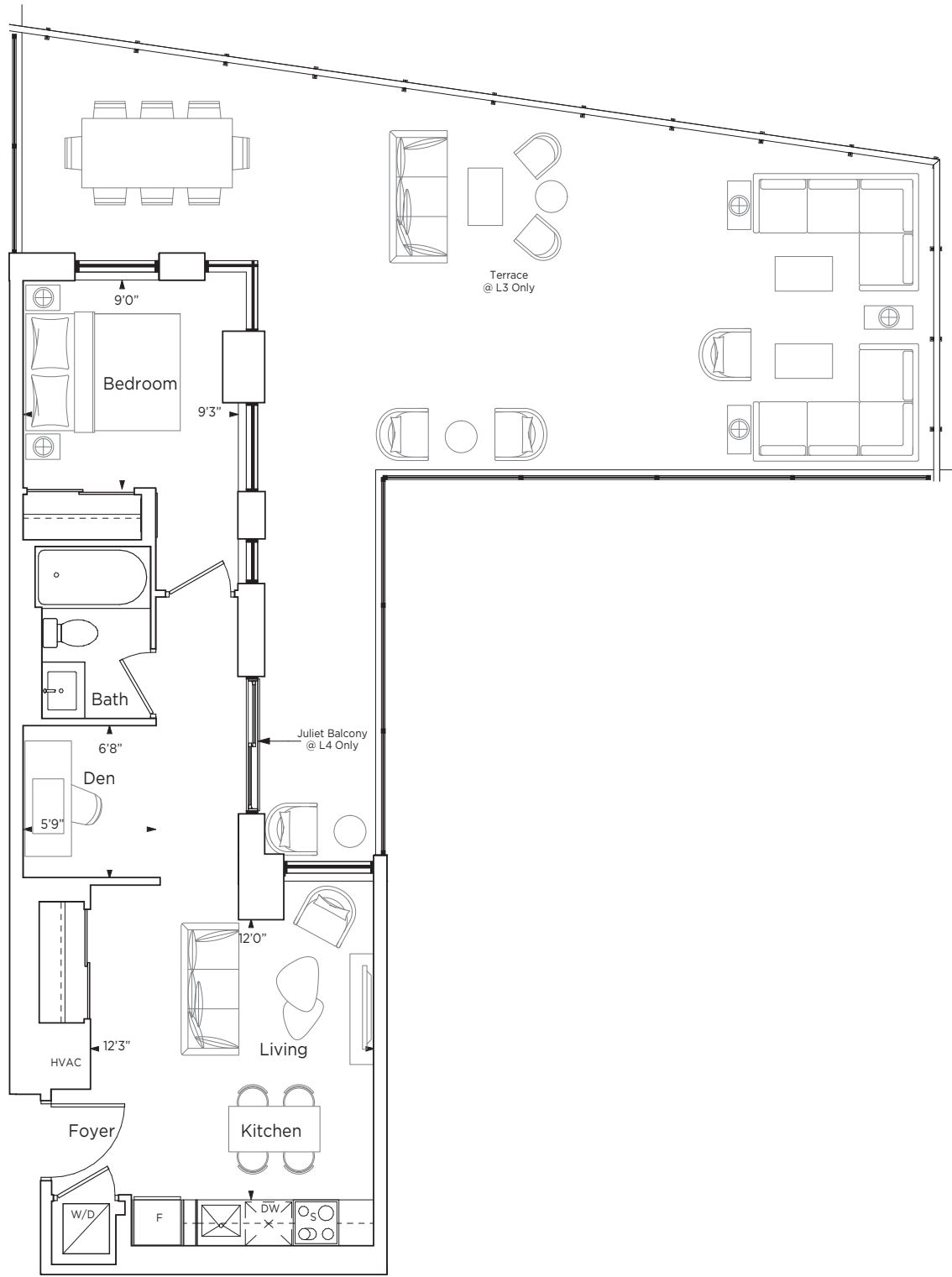

C9

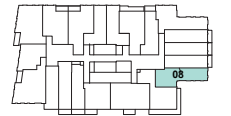

Tower A
LEVEL 4

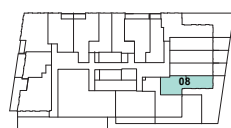

Tower A
LEVEL 3



Vincent
CONDOMINIUMS



Materials, specifications and floor plans are subject to change. All renderings are artist's concept. All floor plans are approximate dimensions. Actual usable floor space may vary from stated floor area. Balcony/terrace areas may vary. Windows, room/area dimensions & square feet may vary due to location within building. Furniture not included. E. & O. E.

ONE BED + DEN

LANGOUSTE

638 SQ.FT. • 579 SQ.FT. TERRACE

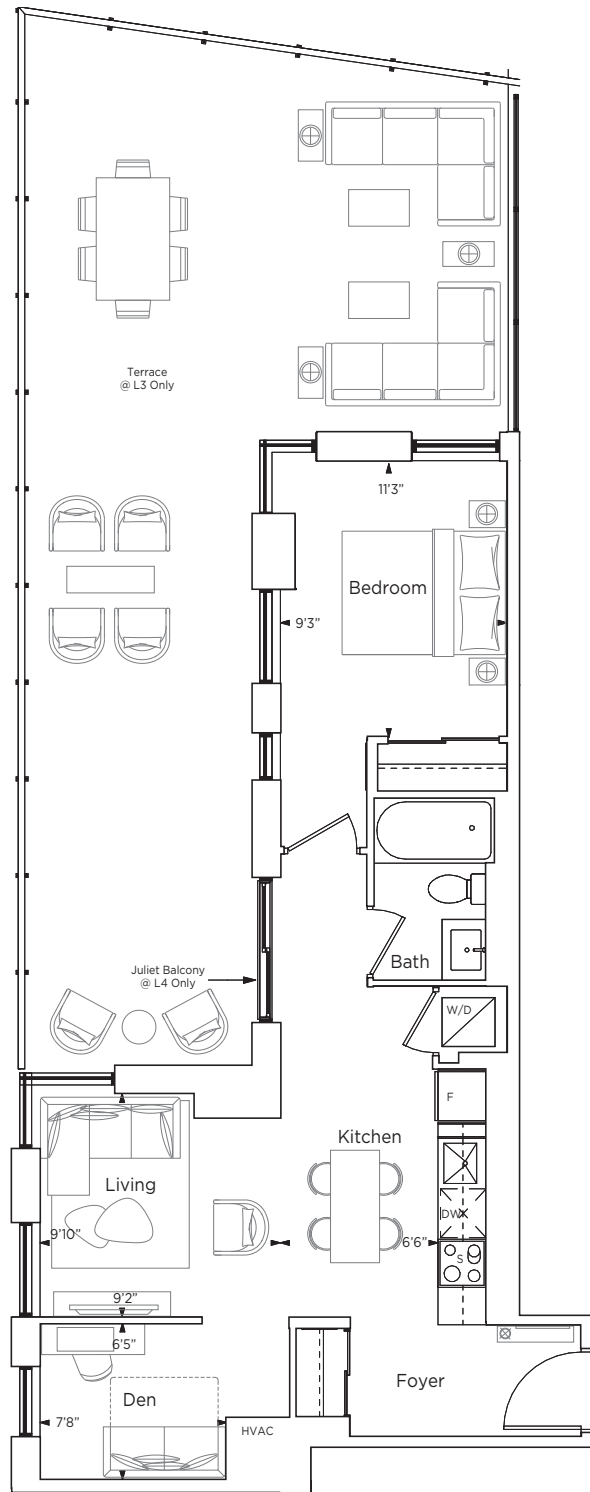

C13



Tower A
LEVEL 4

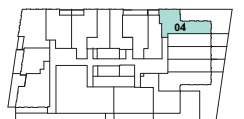

Tower A
LEVEL 3



Vincent
CONDOMINIUMS



Materials, specifications and floor plans are subject to change. All renderings are artist's concept. All floor plans are approximate dimensions. Actual usable floor space may vary from stated floor area. Balcony/terrace areas may vary. Windows, room/area dimensions & square feet may vary due to location within building. Furniture not included. E. & O. E.

STUDIO

BERLIN

440 SQ.FT. • 39 SQ.FT. BALCONY

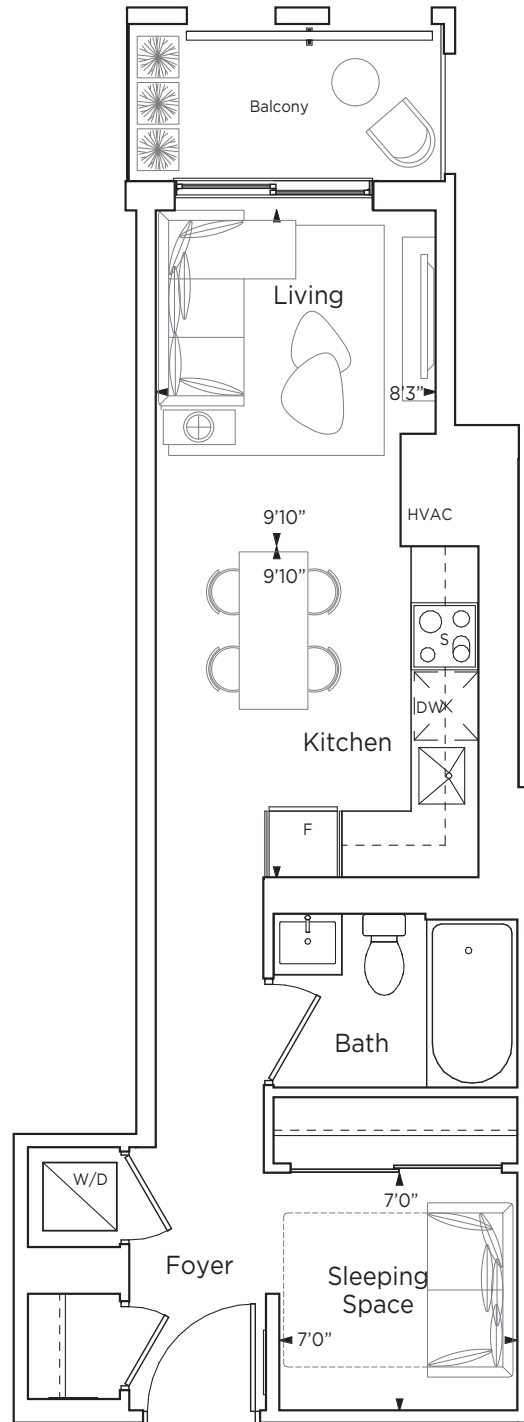

C14



Tower A
LEVEL 4



Tower A
LEVEL 3



Vincent
CONDOMINIUMS



Materials, specifications and floor plans are subject to change. All renderings are artist's concept. All floor plans are approximate dimensions. Actual usable floor space may vary from stated floor area. Balcony/terrace areas may vary. Windows, room/area dimensions & square feet may vary due to location within building. Furniture not included. E. & O. E.

ONE BED + DEN (BARRIER-FREE)

KEY WEST

605 SQ.FT. • 77 SQ.FT. BALCONY • 88 SQ.FT. TERRACE

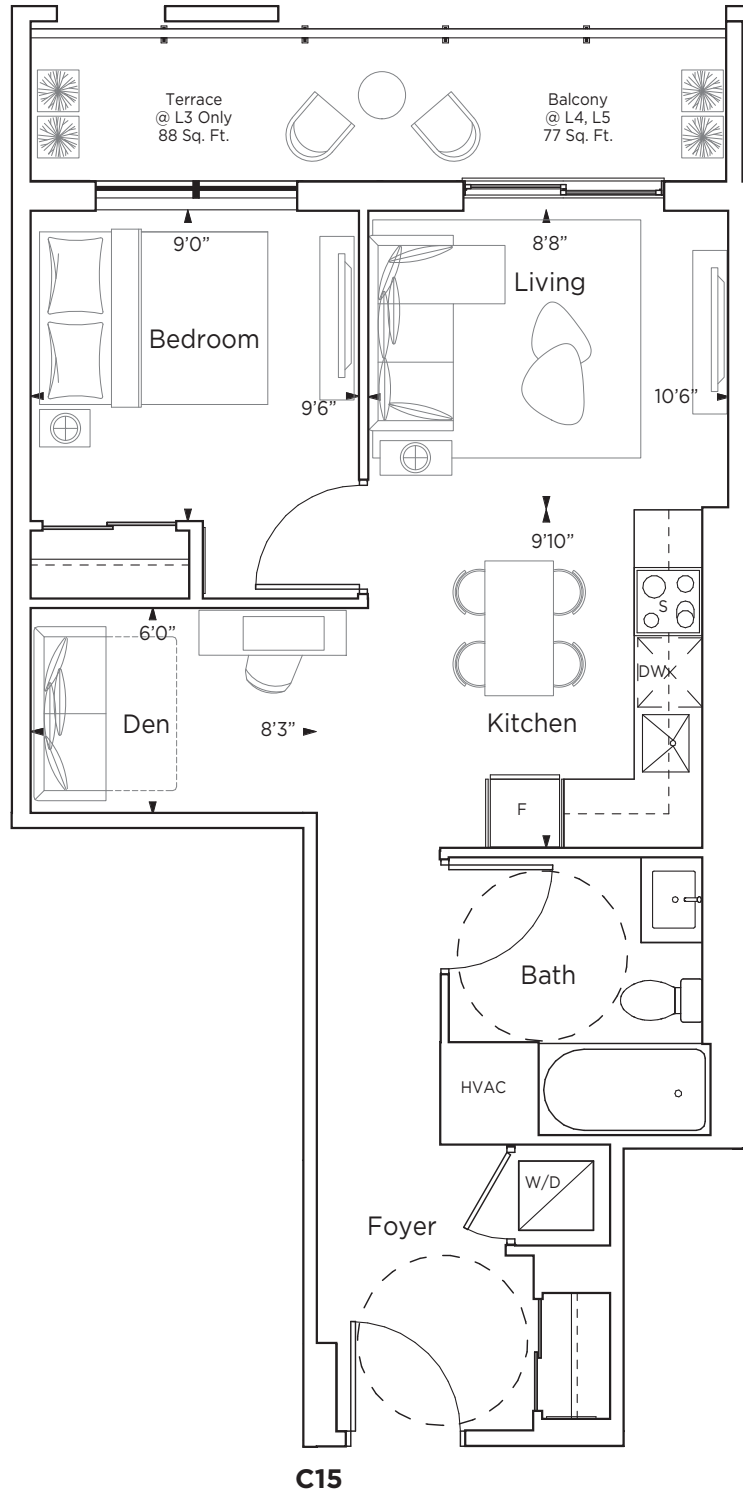

**Tower A
LEVEL 5**



**Tower A
LEVEL 4**

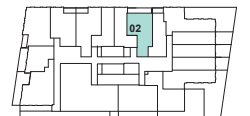

**Tower A
LEVEL 3**



Vincent
CONDOMINIUMS



Materials, specifications and floor plans are subject to change. All renderings are artist's concept. All floor plans are approximate dimensions. Actual usable floor space may vary from stated floor area. Balcony/terrace areas may vary. Windows, room/area dimensions & square feet may vary due to location within building. Furniture not included. E. & O. E.

ONE BED + DEN (BARRIER-FREE)

ISTANBUL

600 SQ.FT. • 80 SQ.FT. TERRACE

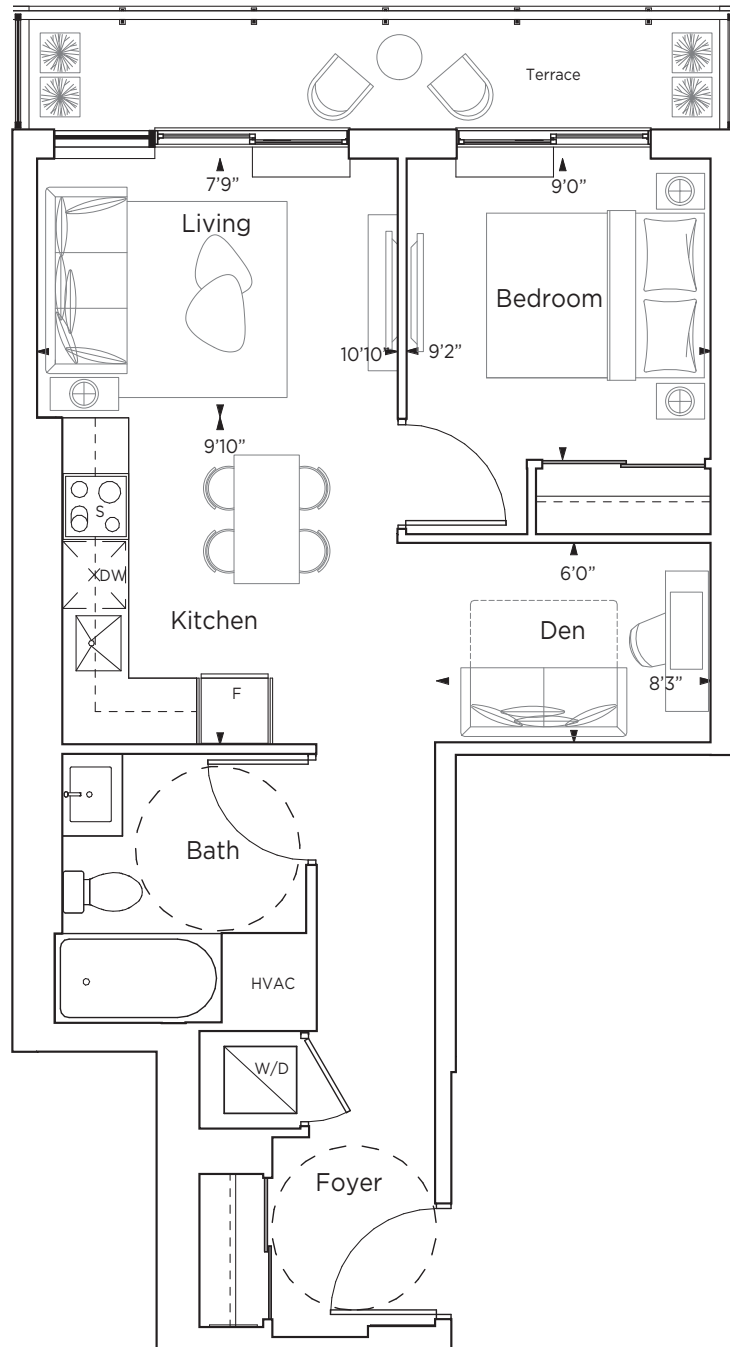

C16



Tower A
LEVEL 6

ONE BED + DEN

FEDORA

595 SQ.FT. • 80 SQ.FT. TERRACE - TOWER A
577 SQ.FT. • 80 SQ.FT. BALCONY • 200 SQ.FT. TERRACE - TOWER B

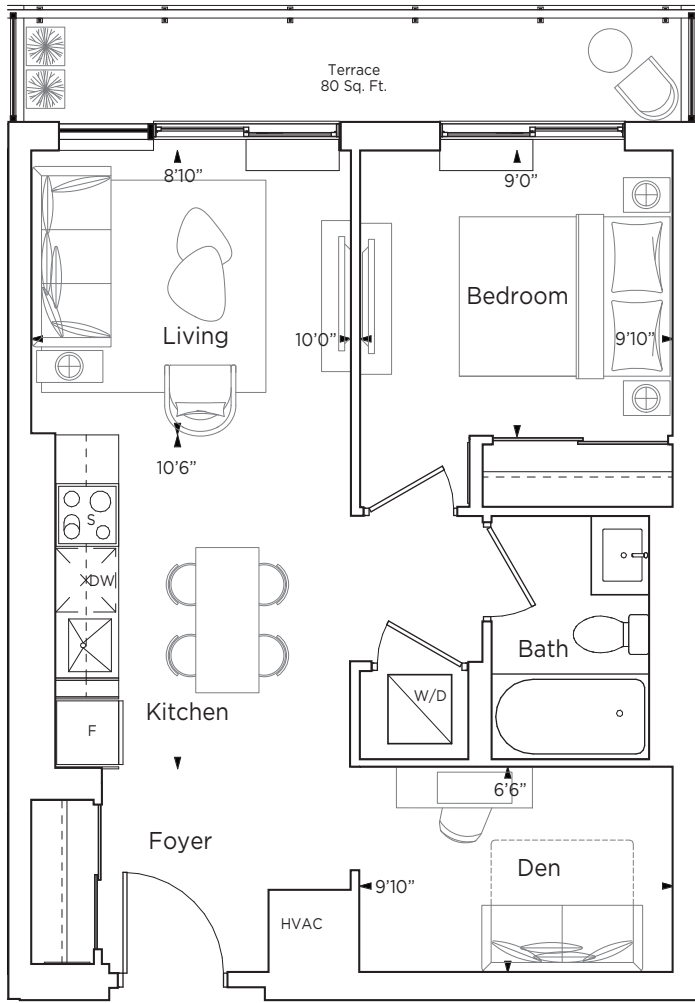

C19-1

TOWER A
595 SQ.FT.

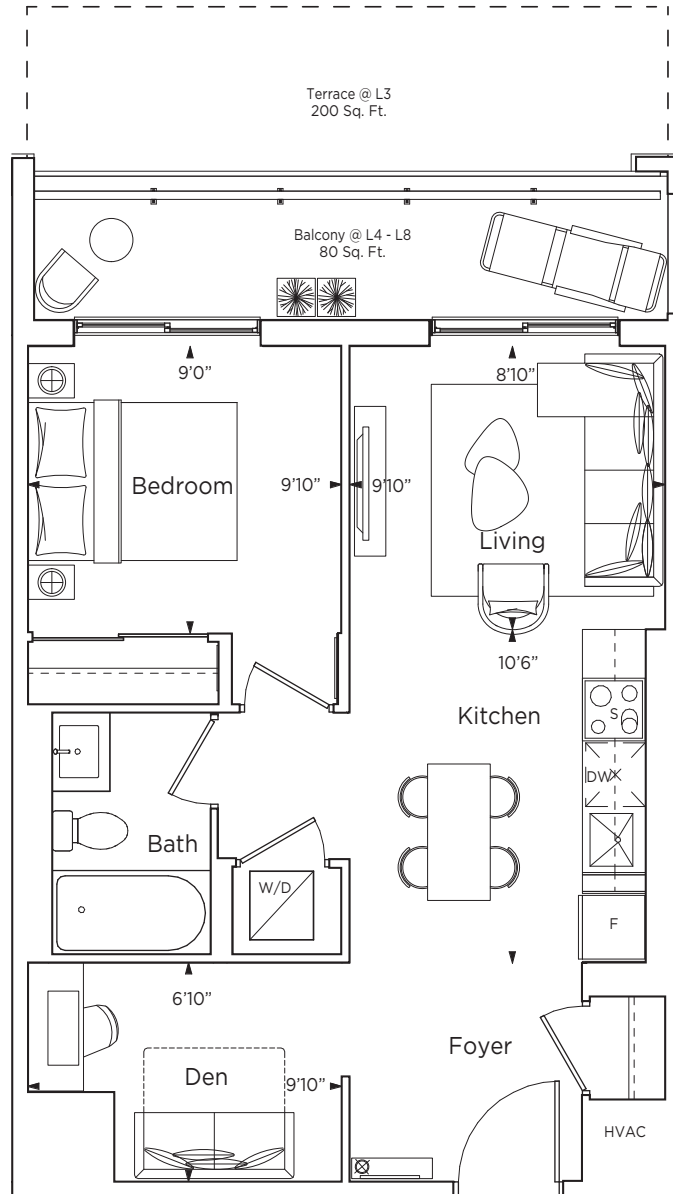

C19-2

TOWER B
577 SQ.FT.

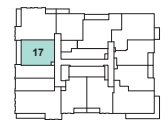

Tower B
LEVEL 7 - 8



Tower B
LEVEL 6

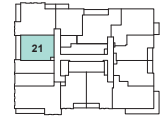

Tower B
LEVEL 5

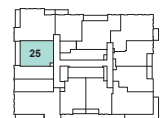

Tower B
LEVEL 4

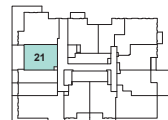

Tower B
LEVEL 3

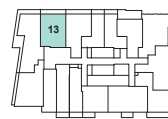

Tower A
LEVEL 6



Vincent
CONDOMINIUMS



Materials, specifications and floor plans are subject to change. All renderings are artist's concept. All floor plans are approximate dimensions. Actual usable floor space may vary from stated floor area. Balcony/terrace areas may vary. Windows, room/area dimensions & square feet may vary due to location within building. Furniture not included. E. & O. E.

TWO BED

NASSAU

760 SQ.FT. D6-2 • 356 SQ.FT. TERRACE @ LEVEL 3

744 SQ.FT. D6-1

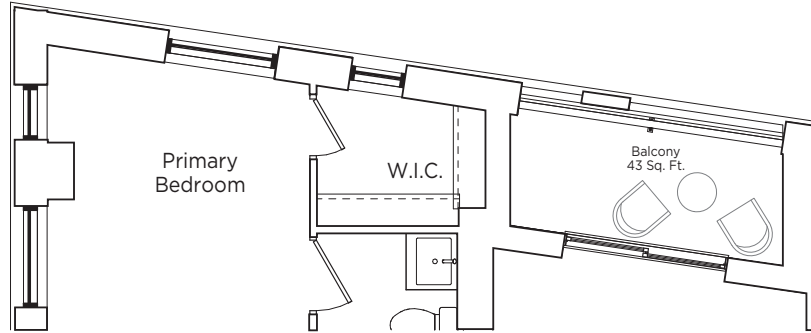

D6-1 BALCONY PLAN AT LEVEL 4, 5

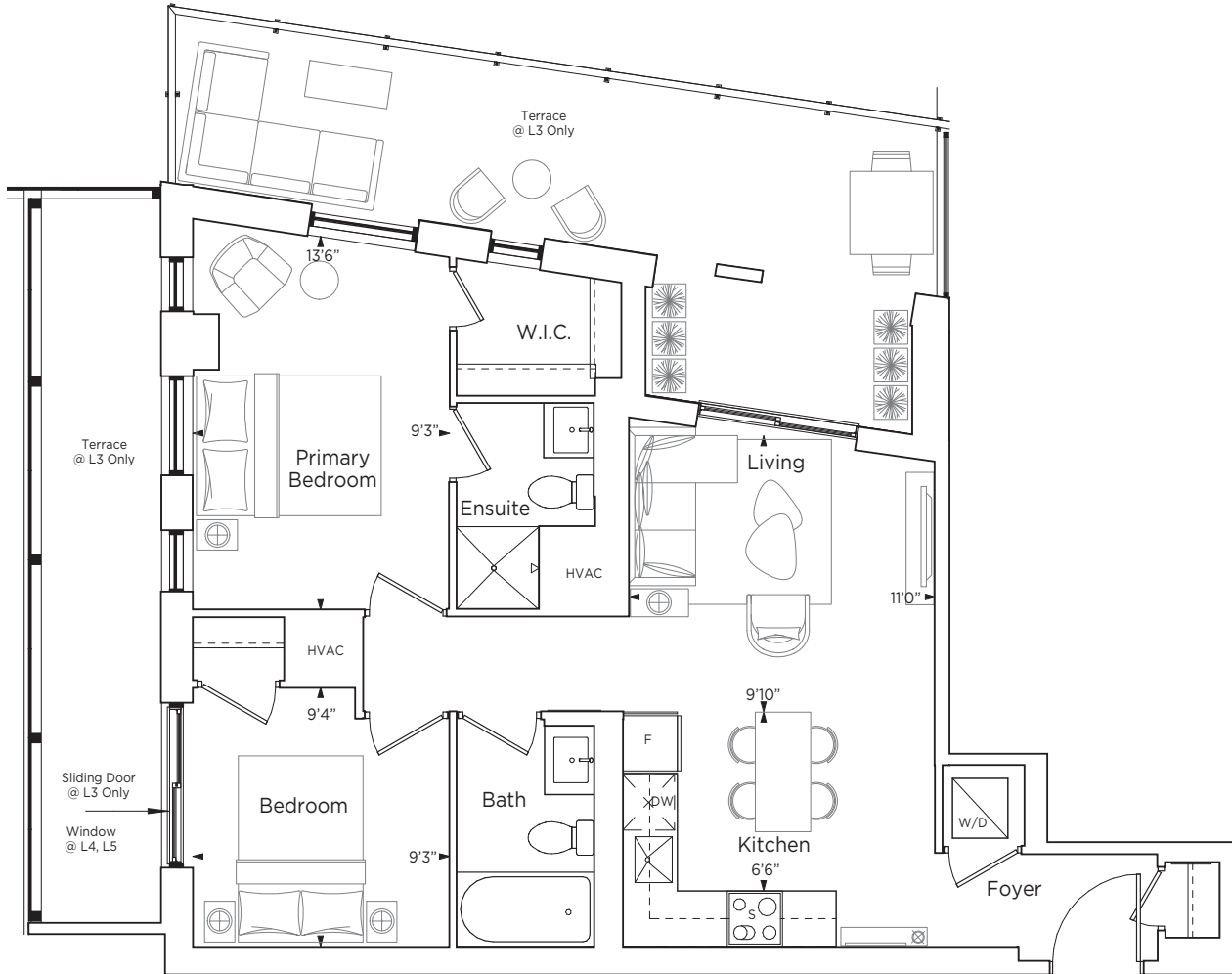

D6-2



Tower A
LEVEL 5

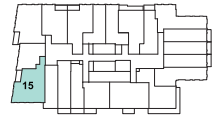

Tower A
LEVEL 4



Tower A
LEVEL 3



Vincent
CONDOMINIUMS



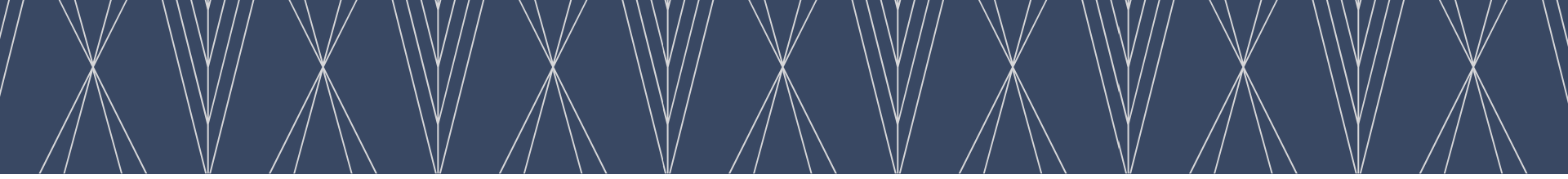

STUDIO

BLACK TIE

441 SQ.FT. • 48 SQ.FT. BALCONY

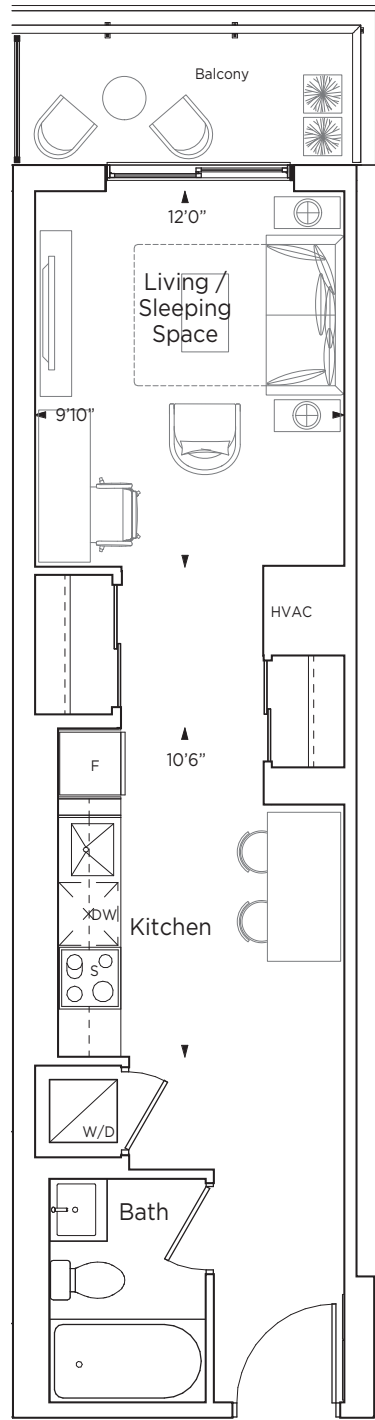

D8



Tower A
LEVEL 6



Tower A
LEVEL 5



Tower A
LEVEL 4



Vincent
CONDOMINIUMS



Materials, specifications and floor plans are subject to change. All renderings are artist's concept. All floor plans are approximate dimensions. Actual usable floor space may vary from stated floor area. Balcony/terrace areas may vary. Windows, room/area dimensions & square feet may vary due to location within building. Furniture not included. E. & O. E.

STUDIO

BAJA

396 SQ.FT. • 49 SQ.FT. BALCONY

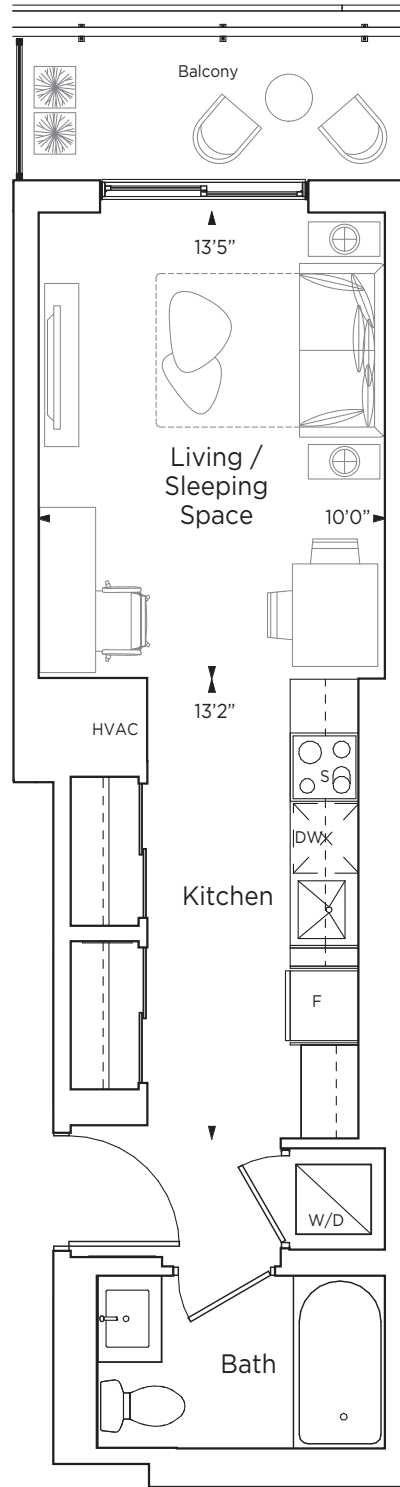

D9



Tower A
LEVEL 6

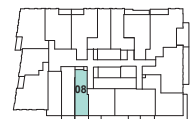

Tower A
LEVEL 5



Tower A
LEVEL 4



Vincent
CONDOMINIUMS



ONE BED + DEN (BARRIER-FREE)

KINGSTON

608 SQ.FT. • 177 SQ.FT. BALCONY. • 514 SQ.FT. TERRACE

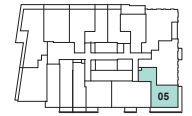
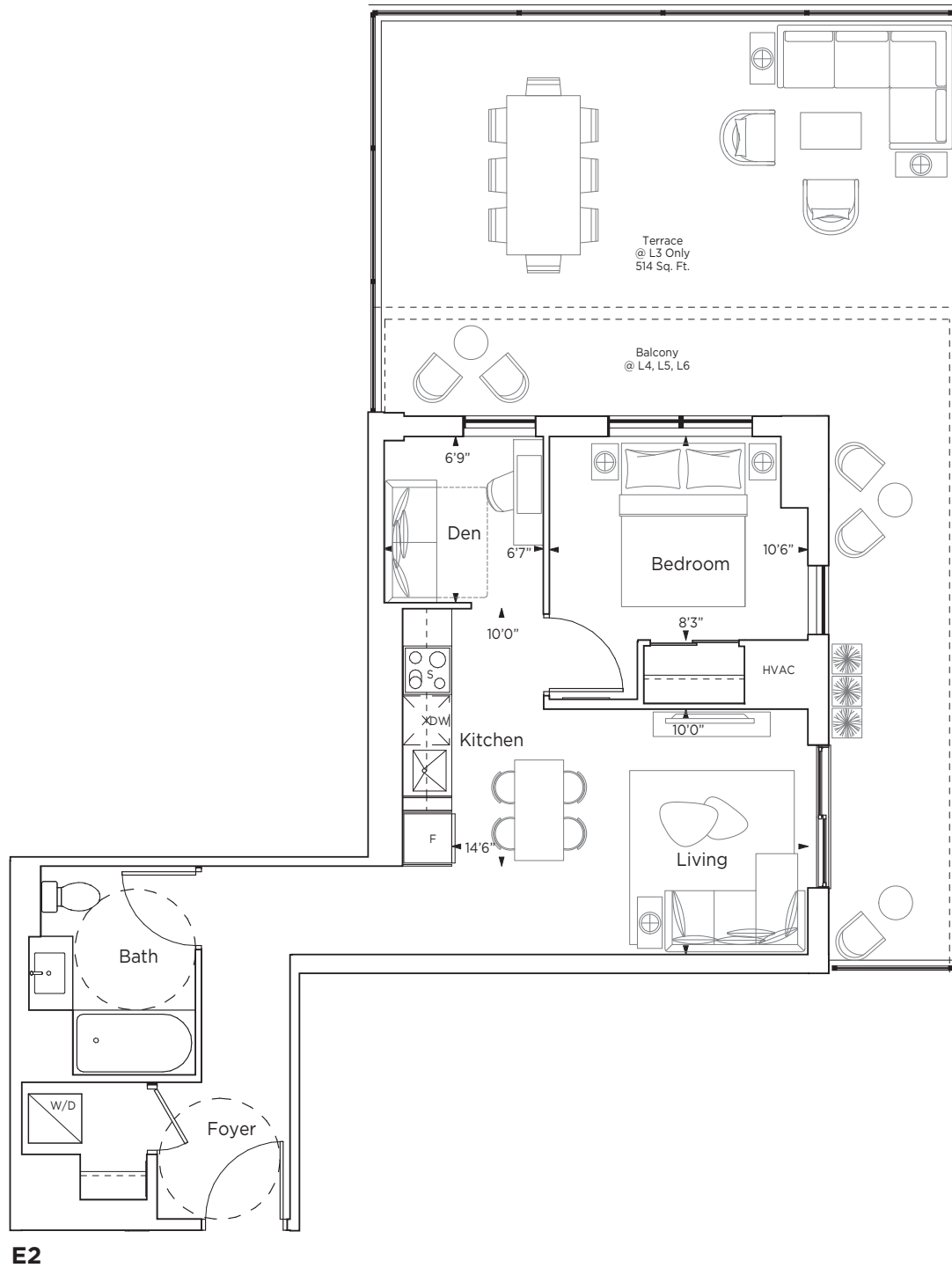

Tower A
LEVEL 6



Tower A
LEVEL 5



Tower A
LEVEL 4

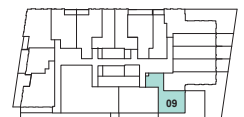

Tower A
LEVEL 3



Vincent
CONDOMINIUMS



TWO BED

SAVILE ROW

802 SQ.FT. • 146 SQ.FT. TERRACE • 33 SQ.FT. BALCONY

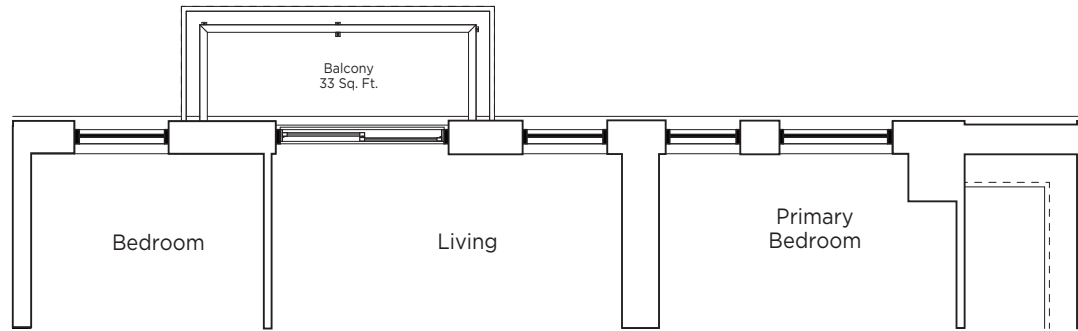

BALCONY PLAN AT LEVEL 6

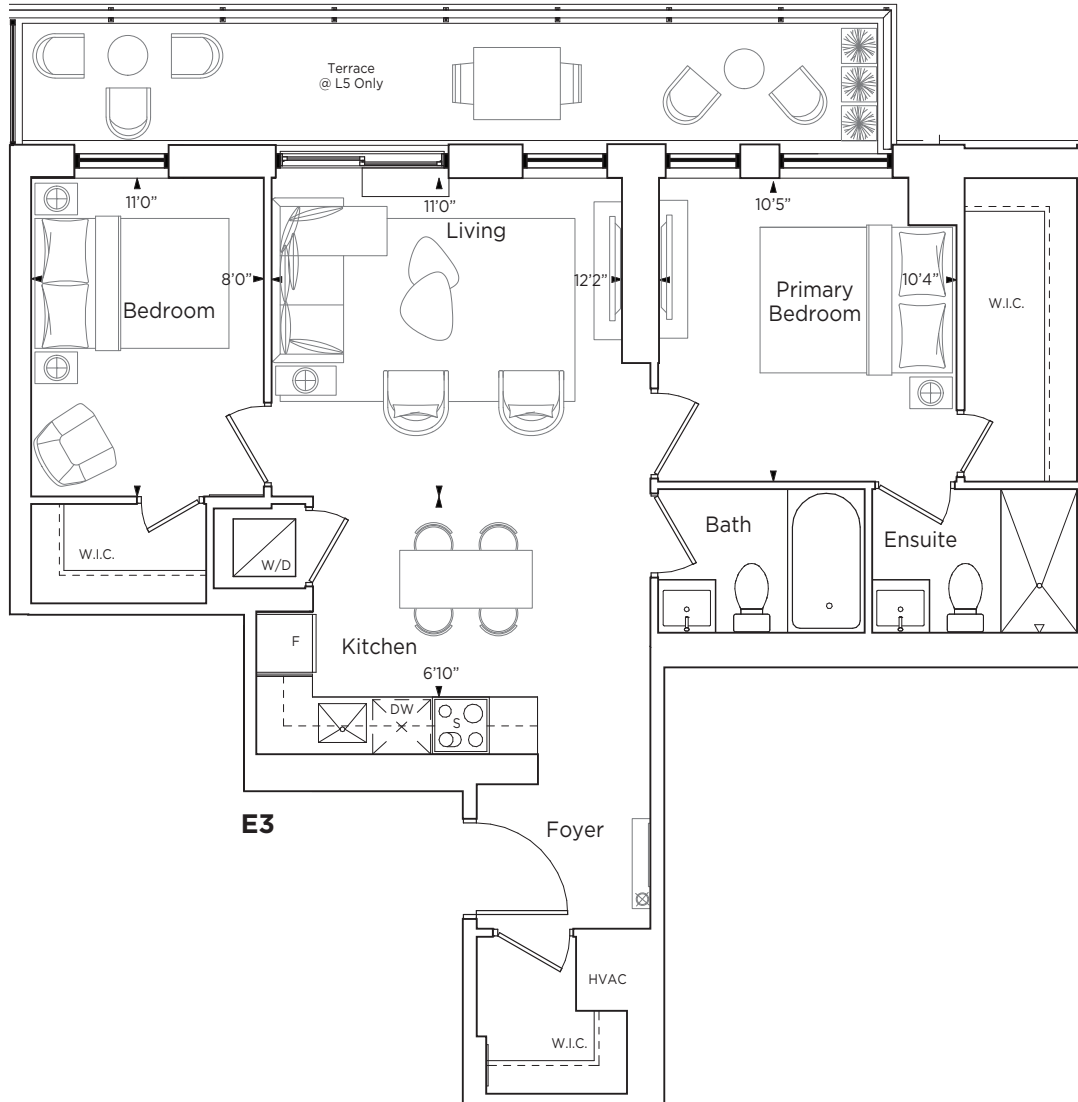

Tower A
LEVEL 6



Tower A
LEVEL 5



Vincent
CONDOMINIUMS



Materials, specifications and floor plans are subject to change. All renderings are artist's concept. All floor plans are approximate dimensions. Actual usable floor space may vary from stated floor area. Balcony/terrace areas may vary. Windows, room/area dimensions & square feet may vary due to location within building. Furniture not included. E. & O. E.

TWO BED

SILVER CLOUD

816 SQ.FT. • 65 SQ.FT. BALCONY • 167 SQ.FT. TERRACE

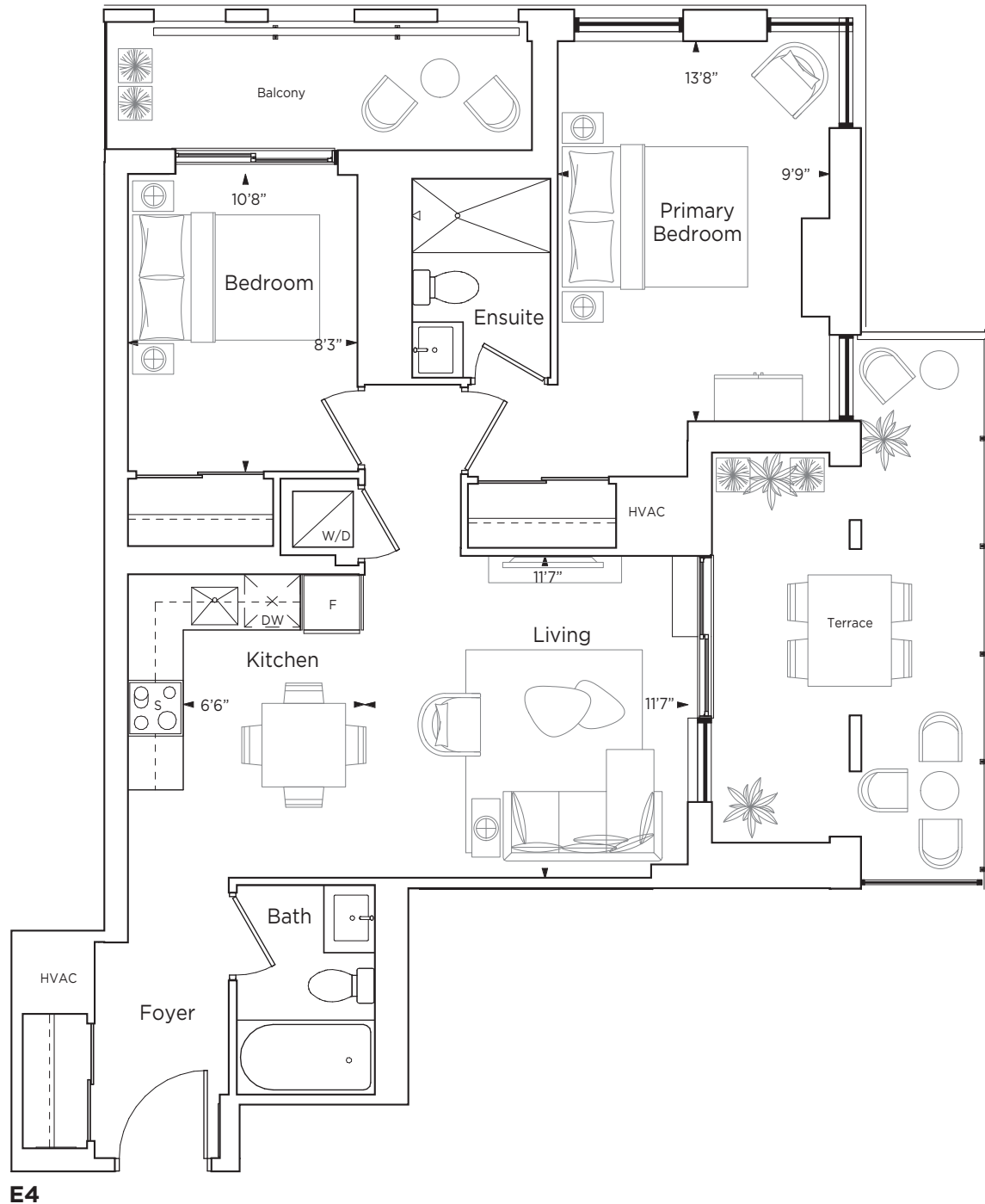

Vincent
CONDOMINIUMS



Tower A
LEVEL 5

Materials, specifications and floor plans are subject to change. All renderings are artist's concept. All floor plans are approximate dimensions. Actual usable floor space may vary from stated floor area. Balcony/terrace areas may vary. Windows, room/area dimensions & square feet may vary due to location within building. Furniture not included. E. & O. E.

STUDIO

ARGYLE

381 SQ.FT. F1-1 • 40 SQ.FT. TERRACE
391 SQ.FT. F1-2 • 42 SQ.FT. TERRACE

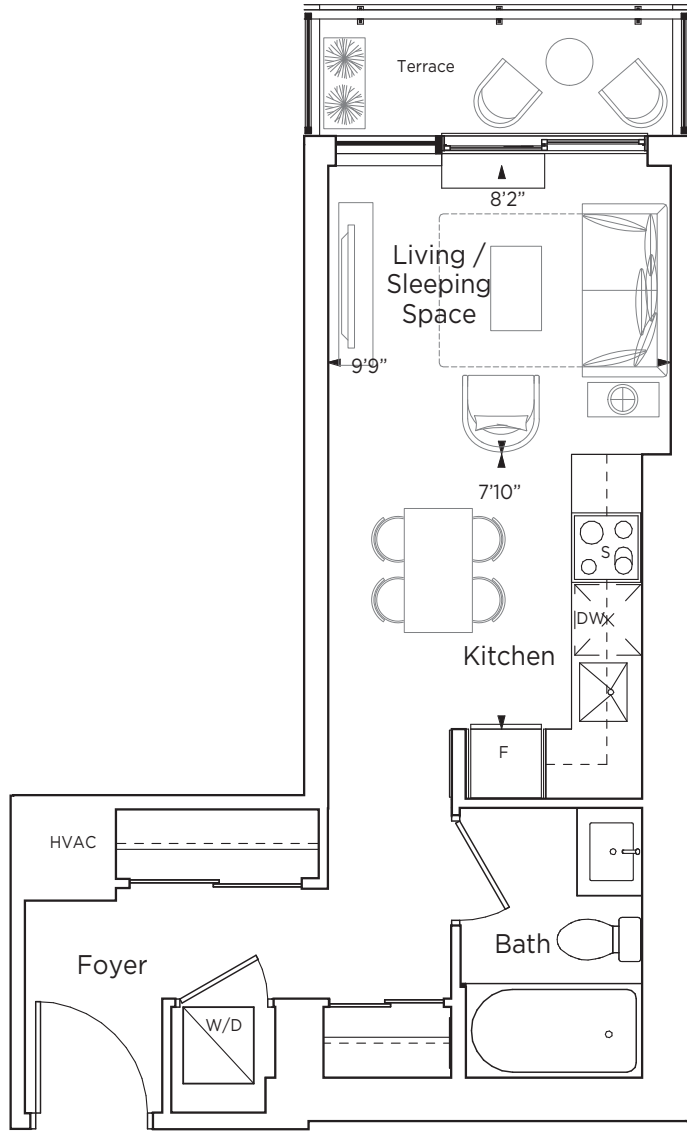

F1-1

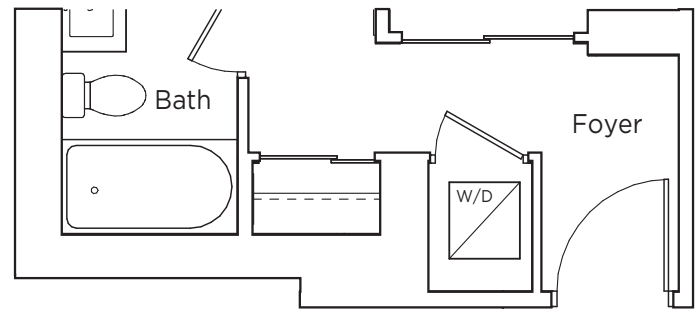

F1-2



Vincent
CONDOMINIUMS

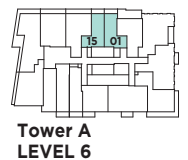

Materials, specifications and floor plans are subject to change. All renderings are artist's concept. All floor plans are approximate dimensions. Actual usable floor space may vary from stated floor area. Balcony/terrace areas may vary. Windows, room/area dimensions & square feet may vary due to location within building. Furniture not included. E. & O. E.

TWO BED

SCOTCH

805 SQ.FT. • 263 SQ.FT. TERRACE

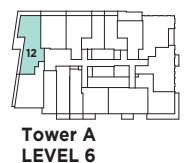
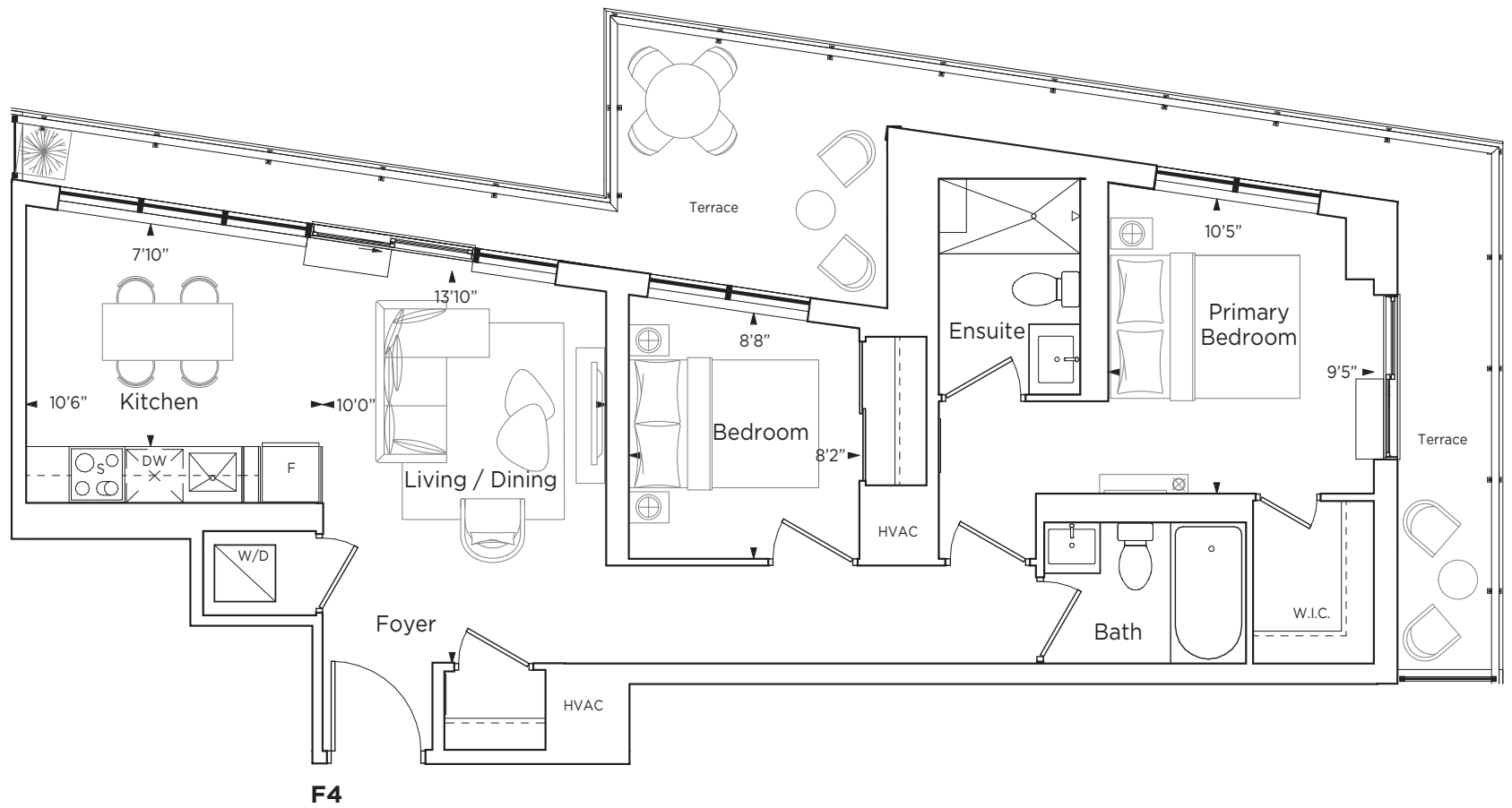

Materials, specifications and floor plans are subject to change. All renderings are artist's concept. All floor plans are approximate dimensions. Actual usable floor space may vary from stated floor area. Balcony/terrace areas may vary. Windows, room/area dimensions & square feet may vary due to location within building. Furniture not included. E. & O. E.

TWO BED

LUXOR

704 SQ.FT. • 67 SQ.FT. TERRACE

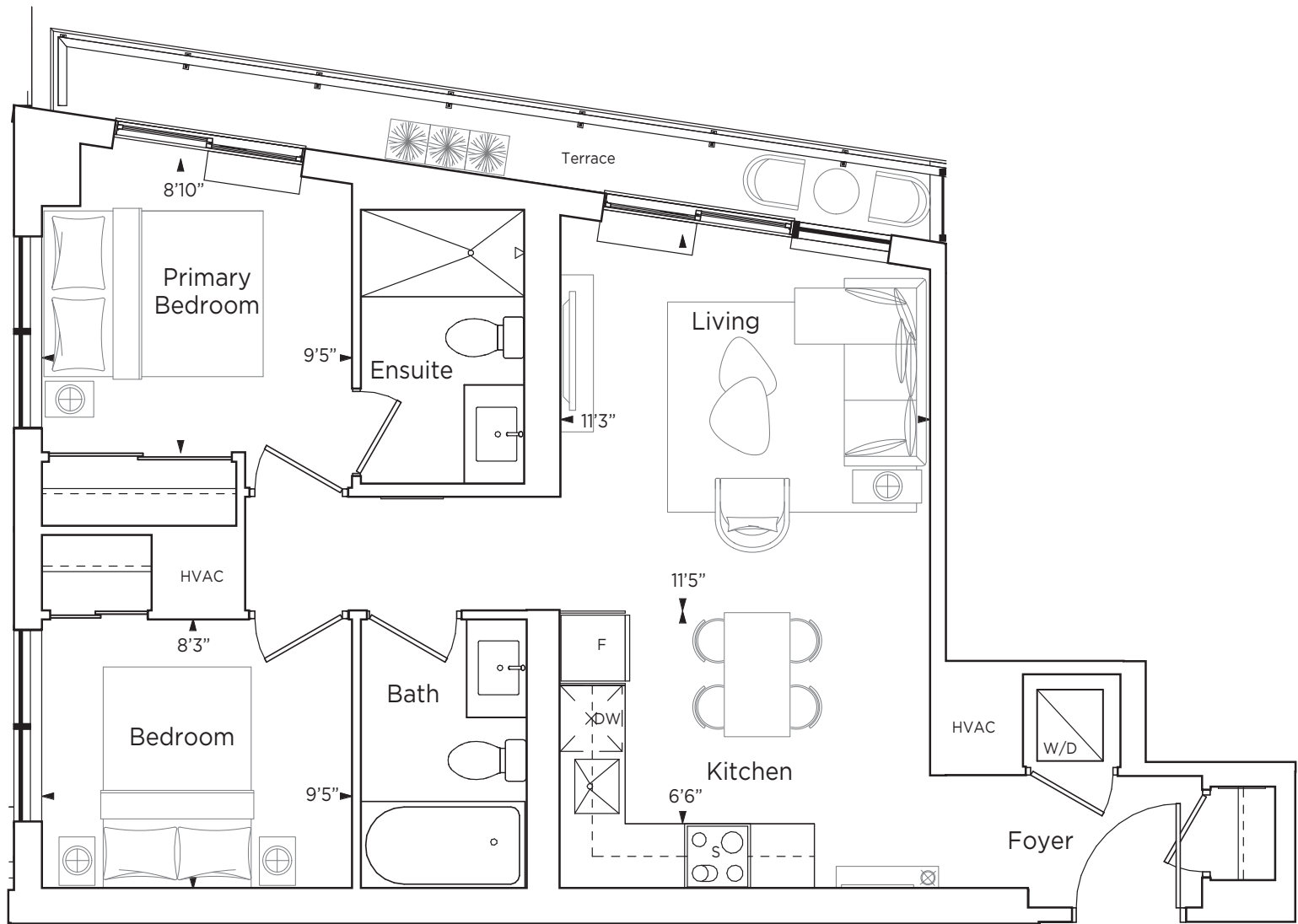

F5

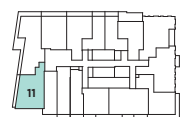

Tower A
LEVEL 6

Materials, specifications and floor plans are subject to change. All renderings are artist's concept. All floor plans are approximate dimensions. Actual usable floor space may vary from stated floor area. Balcony/terrace areas may vary. Windows, room/area dimensions & square feet may vary due to location within building. Furniture not included. E. & O. E.

TWO BED

RIO DE JANIERO

758 SQ.FT. • 66 SQ.FT. BALCONY

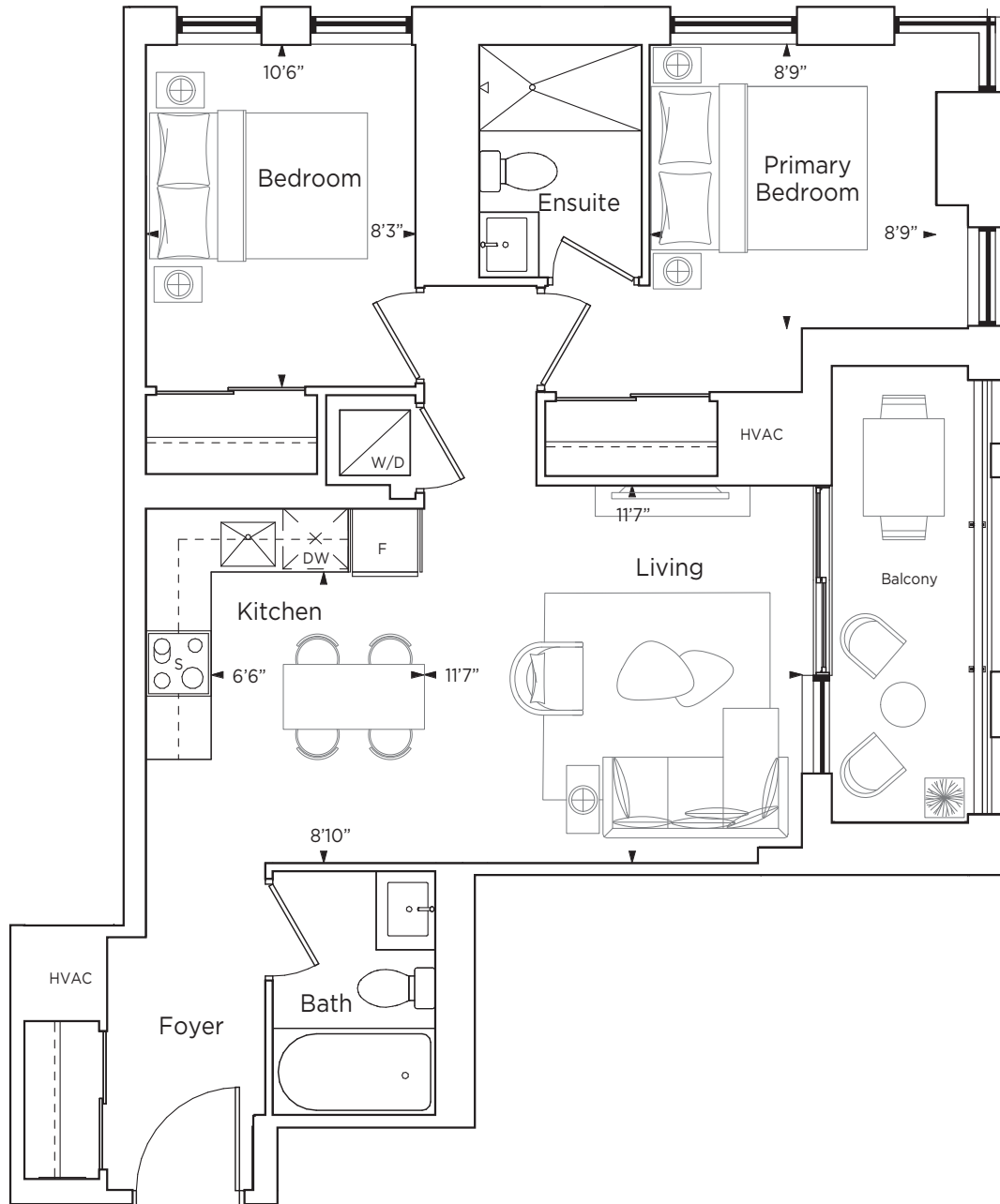

F13



Vincent
CONDOMINIUMS



Tower A
LEVEL 6

Materials, specifications and floor plans are subject to change. All renderings are artist's concept. All floor plans are approximate dimensions. Actual usable floor space may vary from stated floor area. Balcony/terrace areas may vary. Windows, room/area dimensions & square feet may vary due to location within building. Furniture not included. E. & O. E.

ONE BED

CAVIAR

514 SQ.FT. • 152 SQ.FT. TERRACE

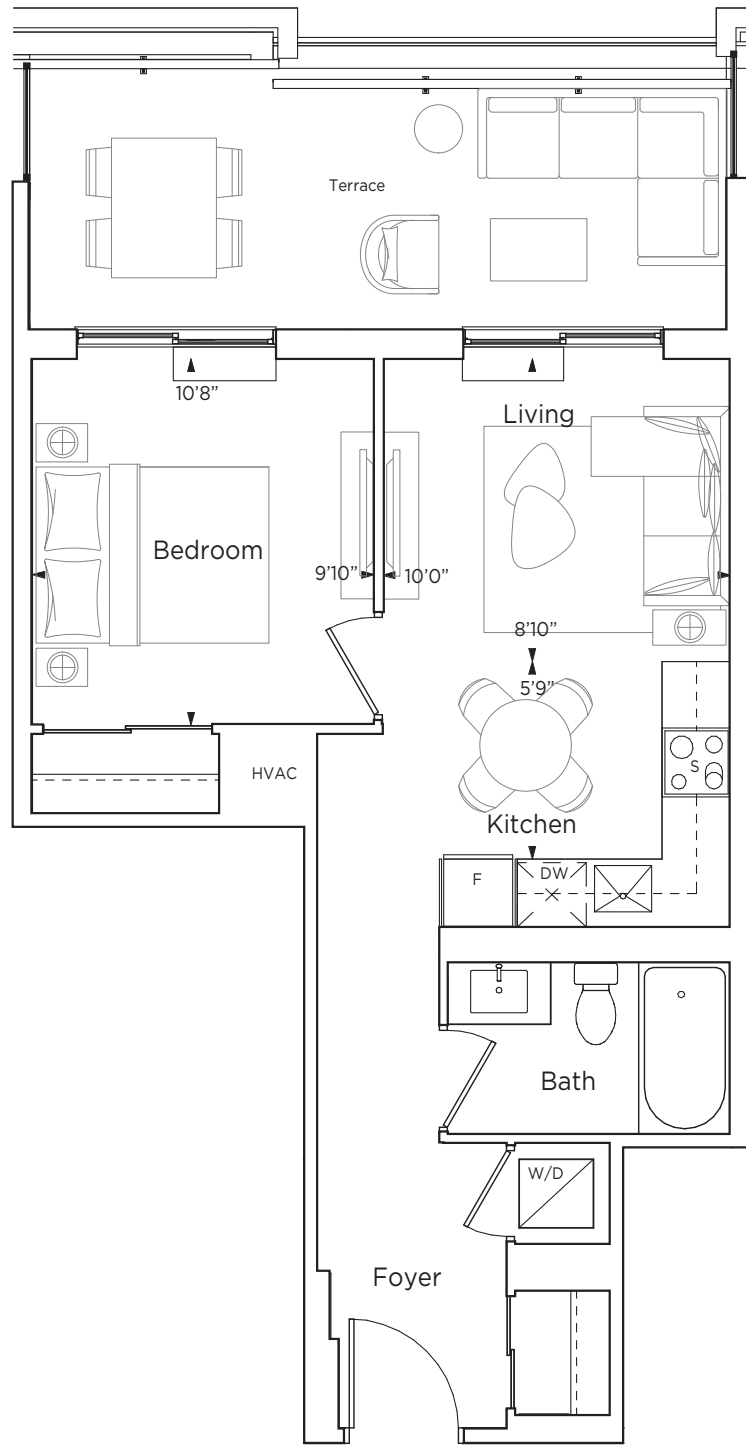

Tower A
LEVEL 6

Materials, specifications and floor plans are subject to change. All renderings are artist's concept. All floor plans are approximate dimensions. Actual usable floor space may vary from stated floor area. Balcony/terrace areas may vary. Windows, room/area dimensions & square feet may vary due to location within building. Furniture not included. E. & O. E.

ONE BED + DEN

ESPRIT

568 SQ.FT. • 36 SQ.FT. BALCONY @ LEVEL 8-37

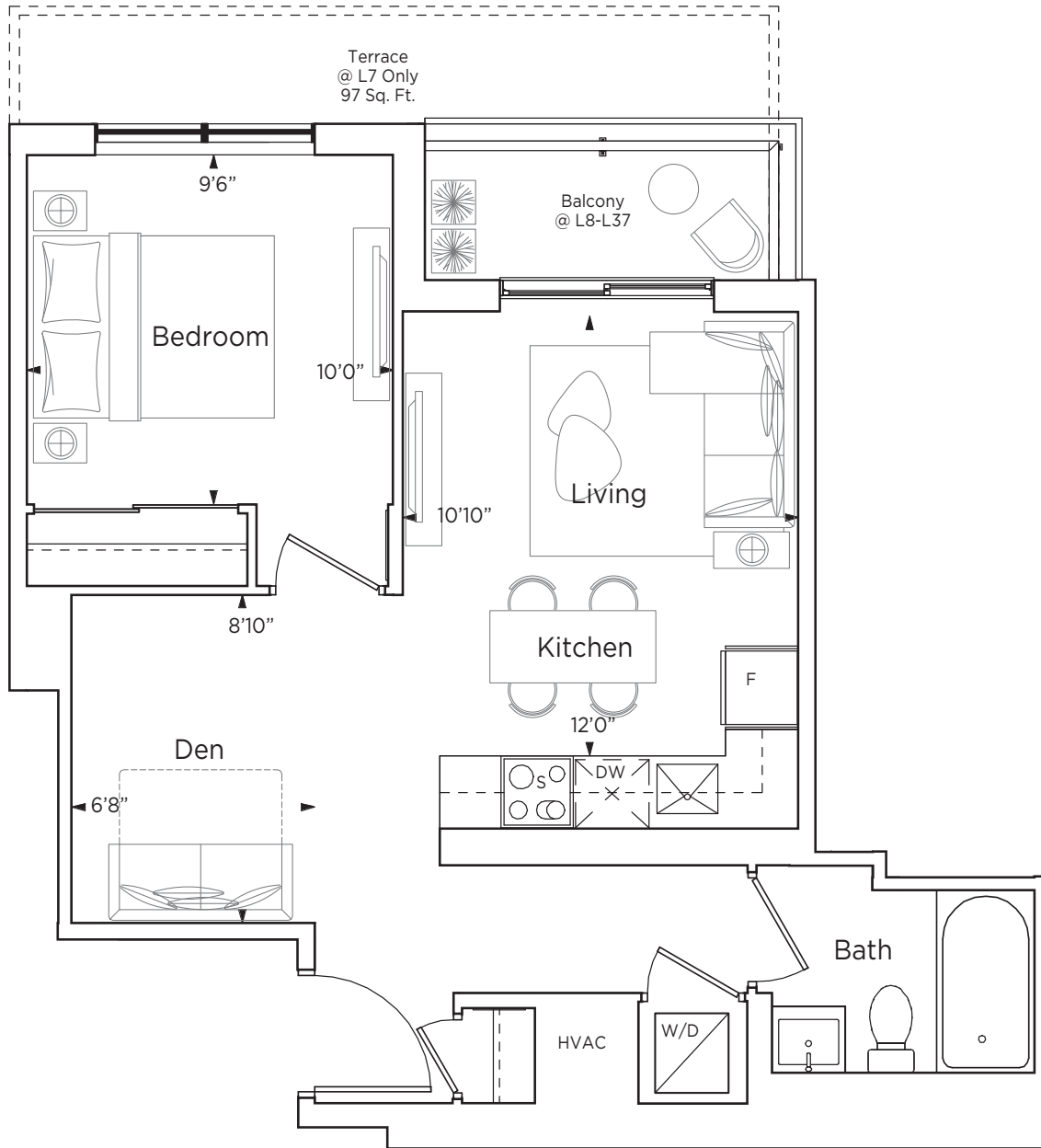

Tower A
LEVEL 35-37



Tower A
LEVEL 8-34

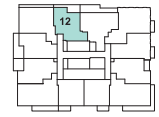

Tower A
LEVEL 7



Vincent
CONDOMINIUMS



TWO BED

MAUI

706 SQ.FT. • 239 SQ.FT. BALCONY • 67 SQ.FT. TERRACE - TOWER A
706 SQ.FT. • 238 SQ.FT. BALCONY • 217 SQ.FT. TERRACE - TOWER B

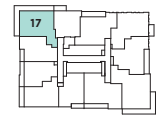
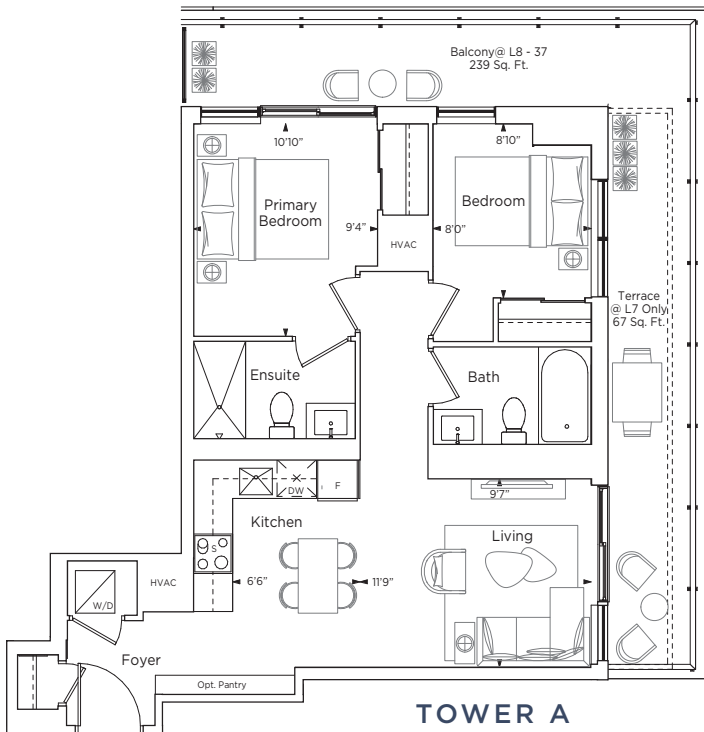
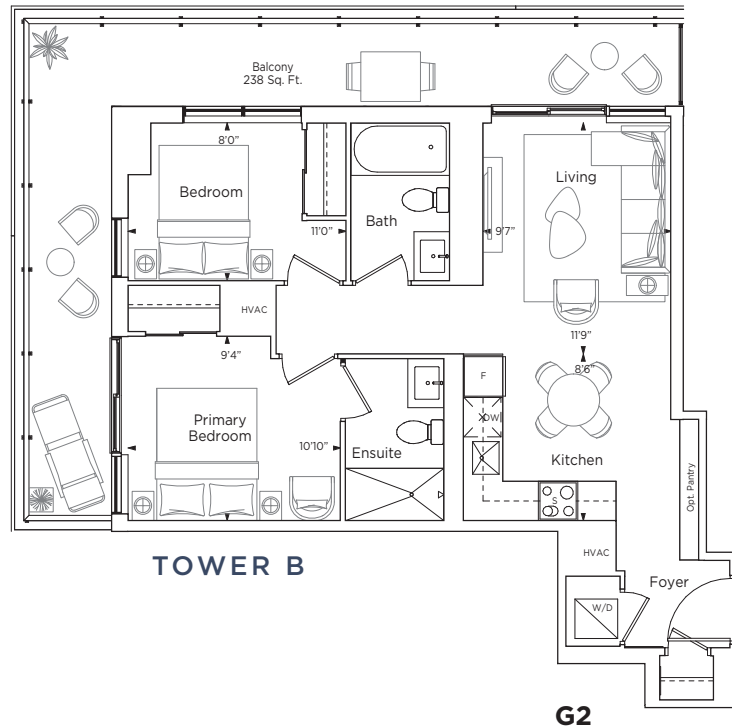
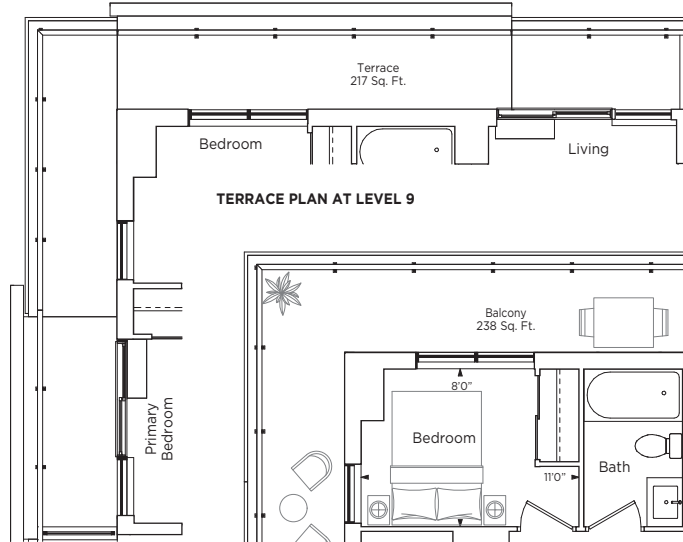

Tower B
LEVEL 25 - 27

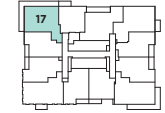

Tower B
LEVEL 15 - 24

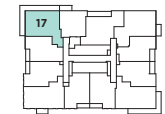

Tower B
LEVEL 10 - 14

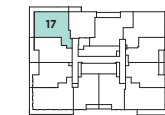

Tower B
LEVEL 9

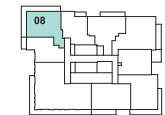

Tower A
LEVEL 35-37



Tower A
LEVEL 8-34



Tower A
LEVEL 7

G2

G2



Vincent
CONDOMINIUMS



Materials, specifications and floor plans are subject to change. All renderings are artist's concept. All floor plans are approximate dimensions. Actual usable floor space may vary from stated floor area. Balcony/terrace areas may vary. Windows, room/area dimensions & square feet may vary due to location within building. Furniture not included. E. & O. E.

ONE BED + DEN

DOLOMITES

561 SQ.FT.

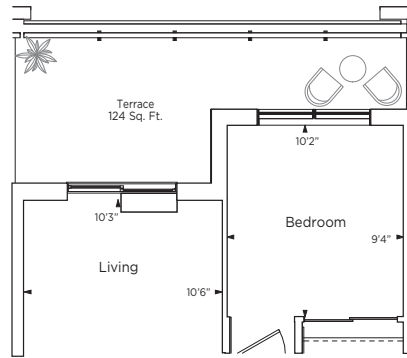
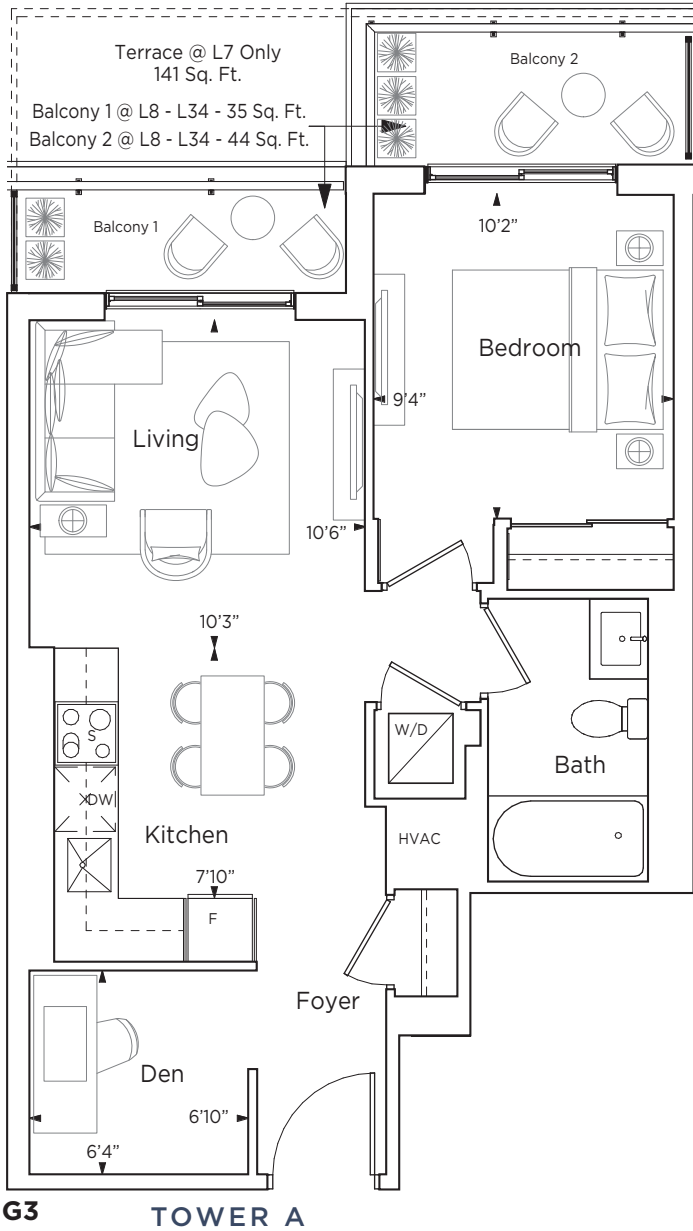

TERRACE PLAN AT LEVEL 9

TOWER B

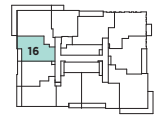
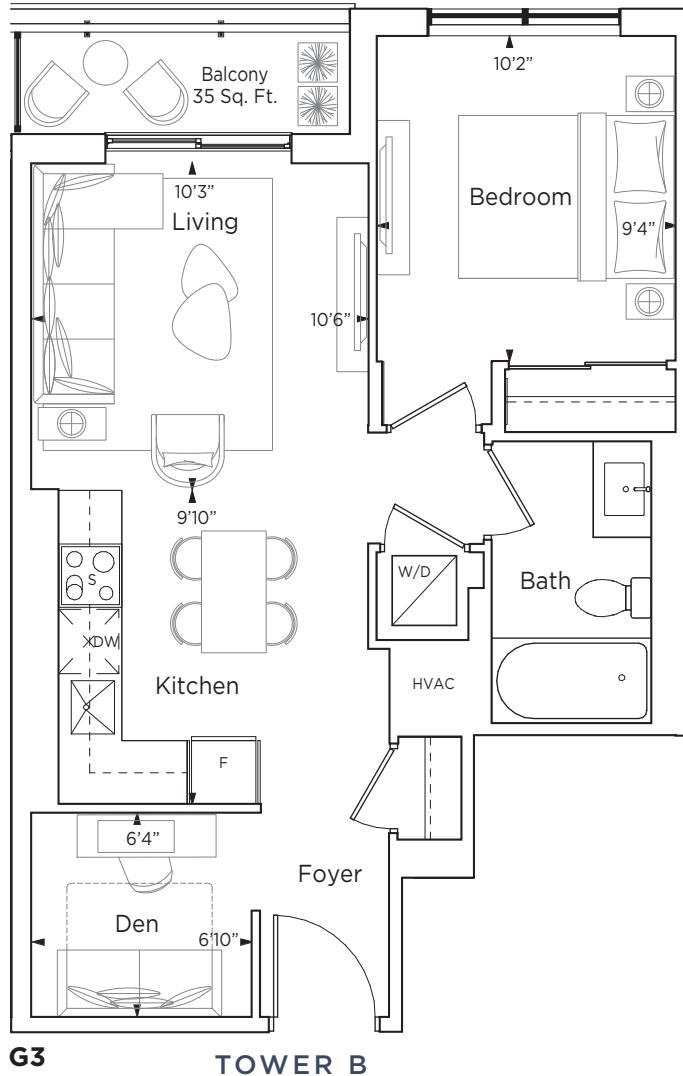

Tower B
LEVEL 25 - 27

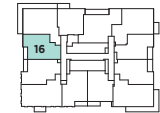

Tower B
LEVEL 15 - 24

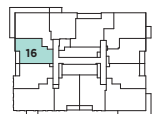

Tower B
LEVEL 10 - 14

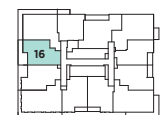

Tower B
LEVEL 9

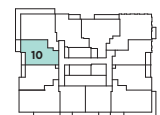

Tower A
LEVEL 15-34

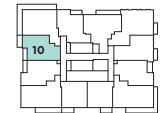

Tower A
LEVEL 8-14

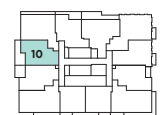

Tower A
LEVEL 7



Vincent
CONDOMINIUMS



Materials, specifications and floor plans are subject to change. All renderings are artist's concept. All floor plans are approximate dimensions. Actual usable floor space may vary from stated floor area. Balcony/terrace areas may vary. Windows, room/area dimensions & square feet may vary due to location within building. Furniture not included. E. & O. E.

ONE BED + DEN

FARO

571 SQ.FT. • 90 SQ.FT. TERRACE

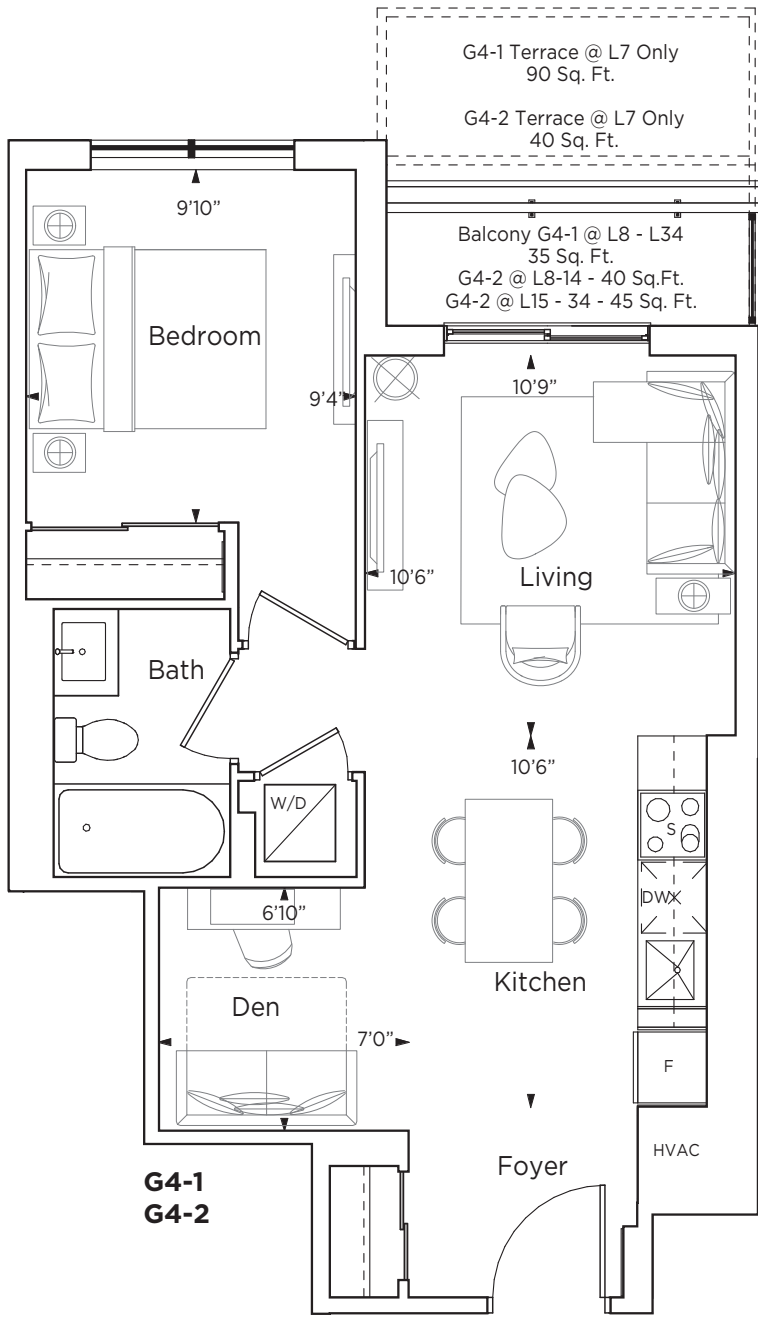

TOWER A

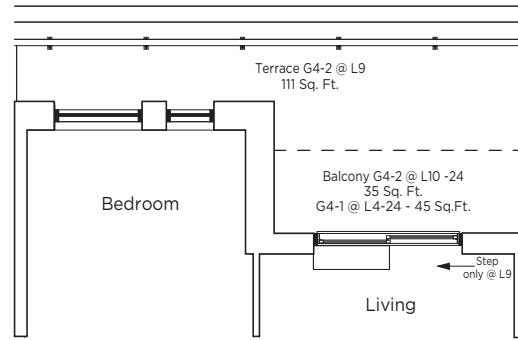

TERRACE PLAN SUITE G4-2 AT LEVEL 9

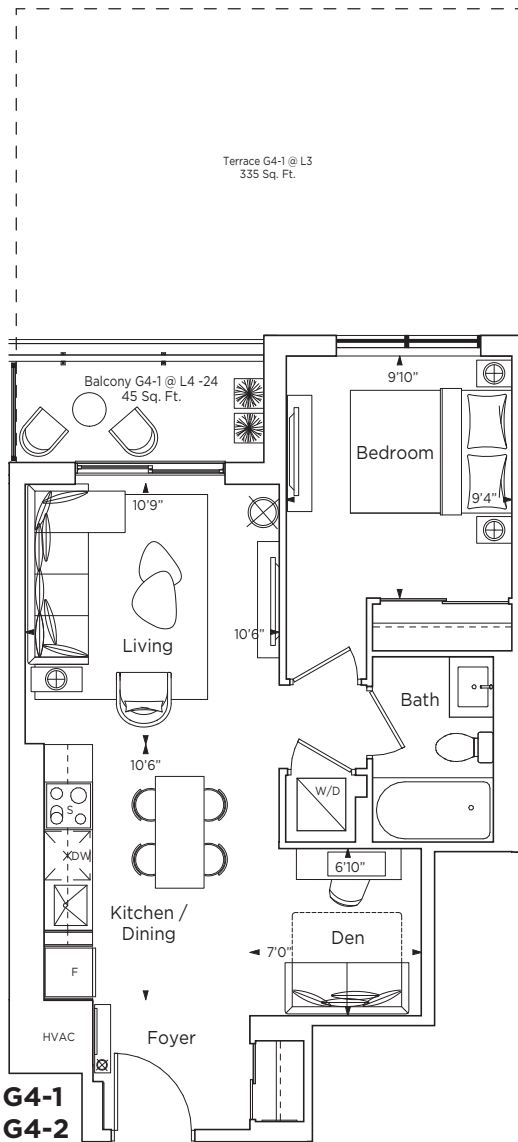

TOWER B



Tower B
LEVEL 15 - 24



Tower B
LEVEL 10 - 14

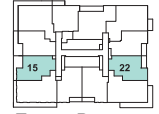

Tower B
LEVEL 9

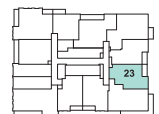

Tower B
LEVEL 7 - 8

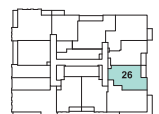

Tower B
LEVEL 6

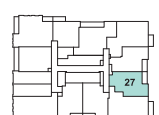

Tower B
LEVEL 5

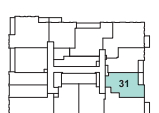

Tower B
LEVEL 4



Tower B
LEVEL 3

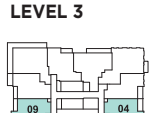

Tower A
LEVEL 15-34

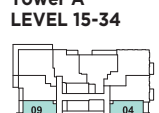

Tower A
LEVEL 8-14

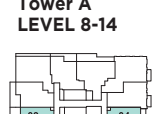

Tower A
LEVEL 7



Vincent
CONDOMINIUMS



TWO BED
MONACO
 706 SQ.FT.

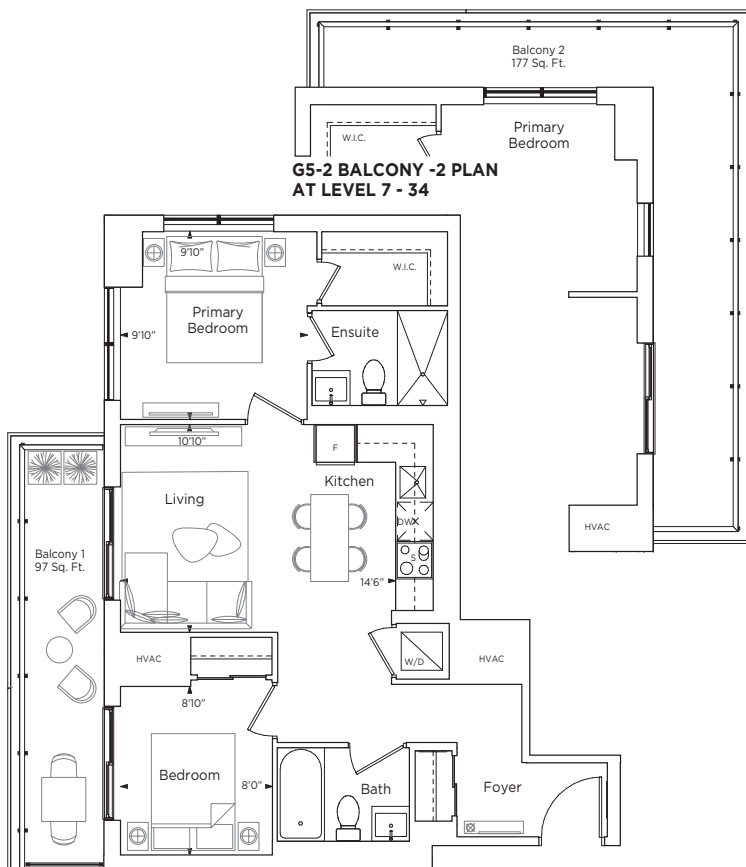

G5-1 TOWER A

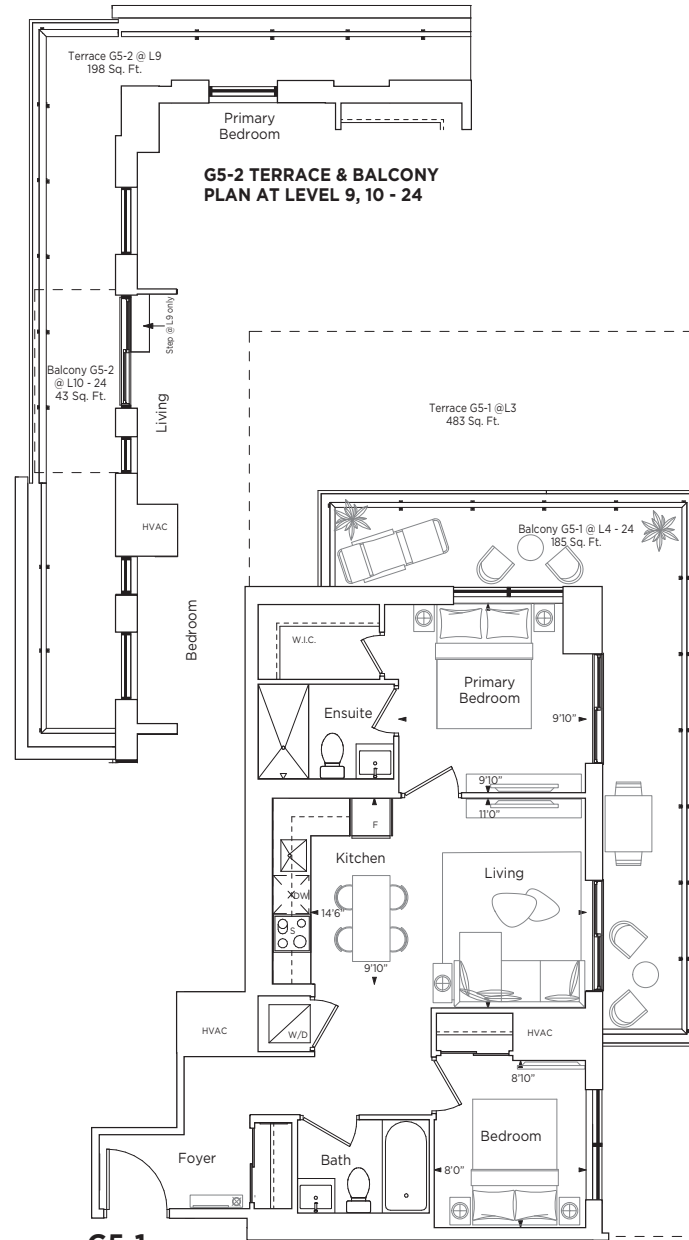

G5-1 TOWER B

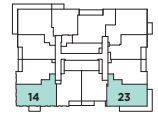

Tower B LEVEL 15 - 24



Tower B LEVEL 10 - 14

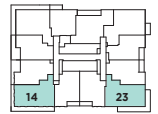

Tower B LEVEL 9

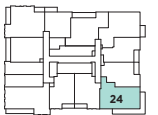

Tower B LEVEL 7 - 8

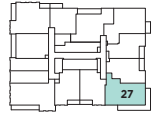

Tower B LEVEL 6

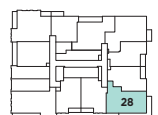

Tower B LEVEL 5

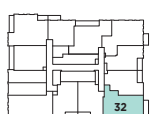

Tower B LEVEL 4

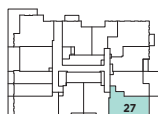

Tower B LEVEL 3

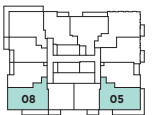

Tower A LEVEL 7 - 34



Materials, specifications and floor plans are subject to change. All renderings are artist's concept. All floor plans are approximate dimensions. Actual usable floor space may vary from stated floor area. Balcony/terrace areas may vary. Windows, room/area dimensions & square feet may vary due to location within building. Furniture not included. E. & O. E.

ONE BED

CARTE BLANCHE

479 SQ.FT. • 43 SQ.FT. BALCONY

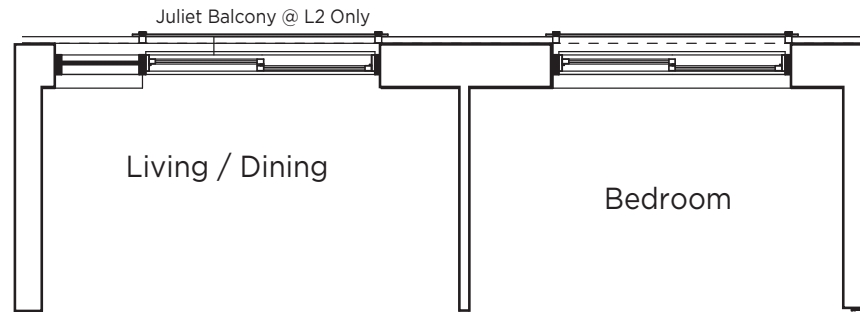

PLAN AT LEVEL 2 - 472 Sq. Ft.

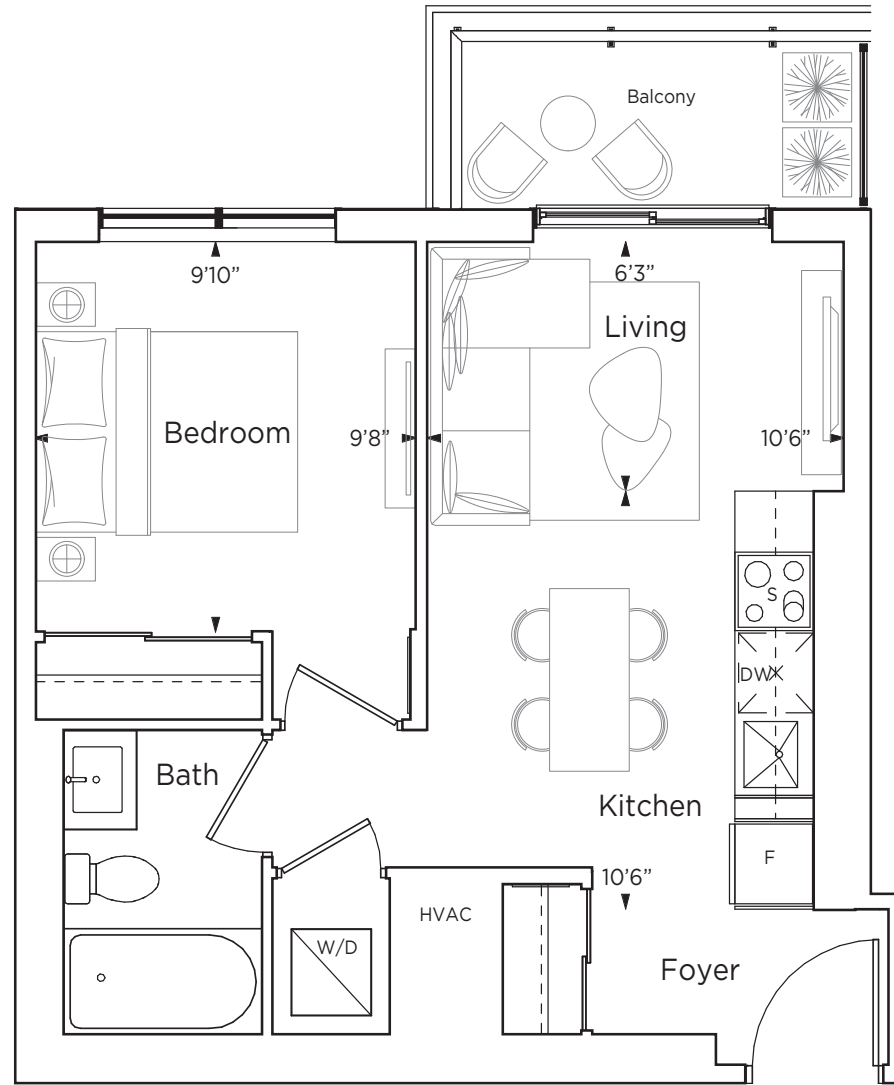

G6

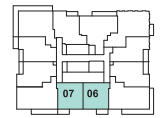

Tower A
LEVEL 15-34



Tower A
LEVEL 7 - 14



Tower A
LEVEL 6



Tower A
LEVEL 5



Tower A
LEVEL 4

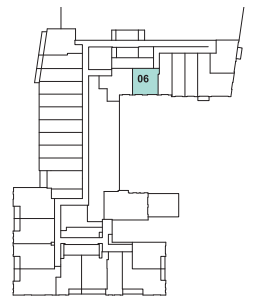

Tower A
LEVEL 2



Vincent
CONDOMINIUMS



ONE BED + DEN

HAVANA

593 SQ.FT. • 33 SQ.FT. BALCONY

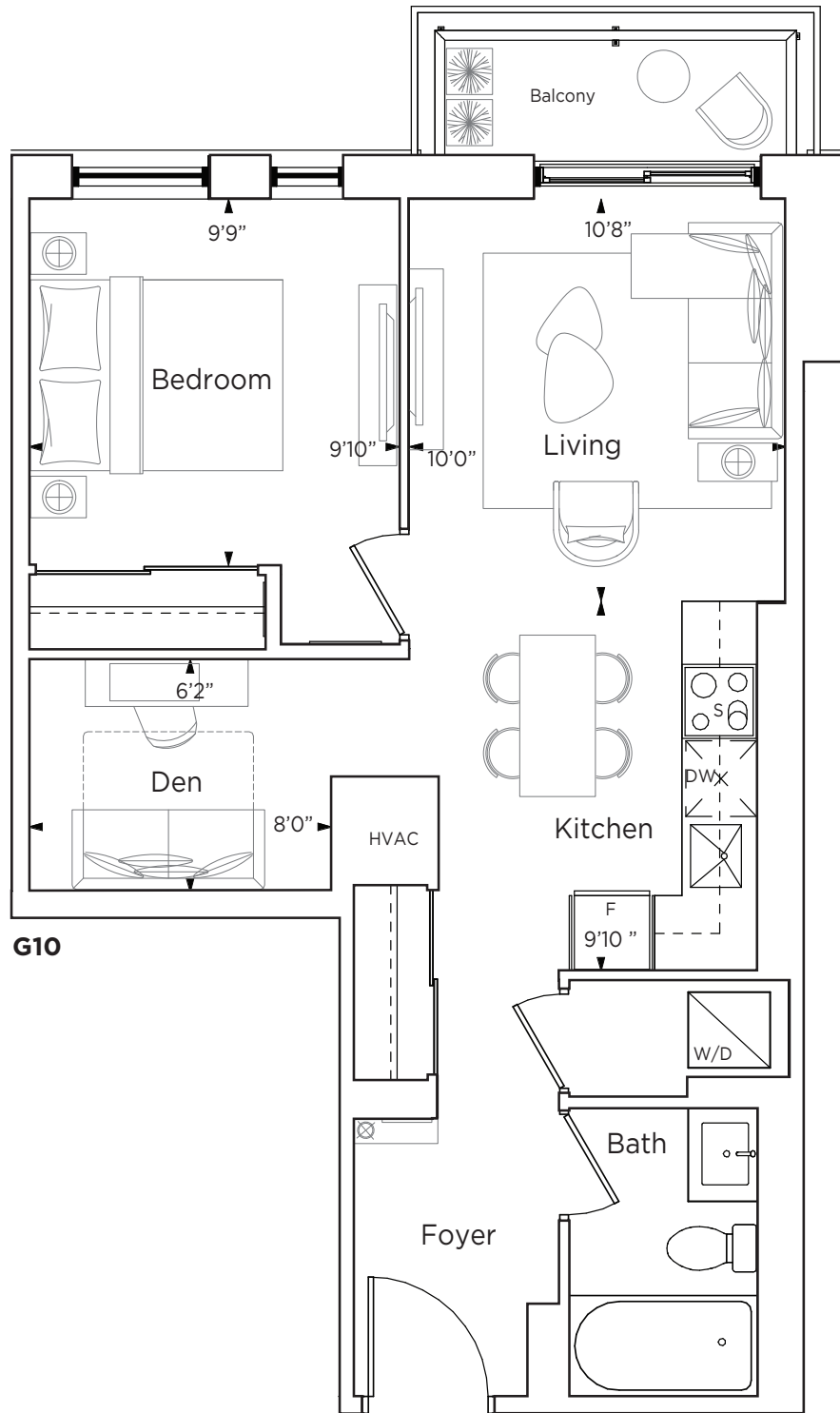

Vincent
CONDOMINIUMS

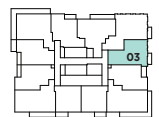

Tower A
LEVEL 7 - 14

Materials, specifications and floor plans are subject to change. All renderings are artist's concept. All floor plans are approximate dimensions. Actual usable floor space may vary from stated floor area. Balcony/terrace areas may vary. Windows, room/area dimensions & square feet may vary due to location within building. Furniture not included. E. & O. E.

TWO BED (BARRIER-FREE)

QUANTUM

754 SQ.FT. • 33 SQ.FT. BALCONY

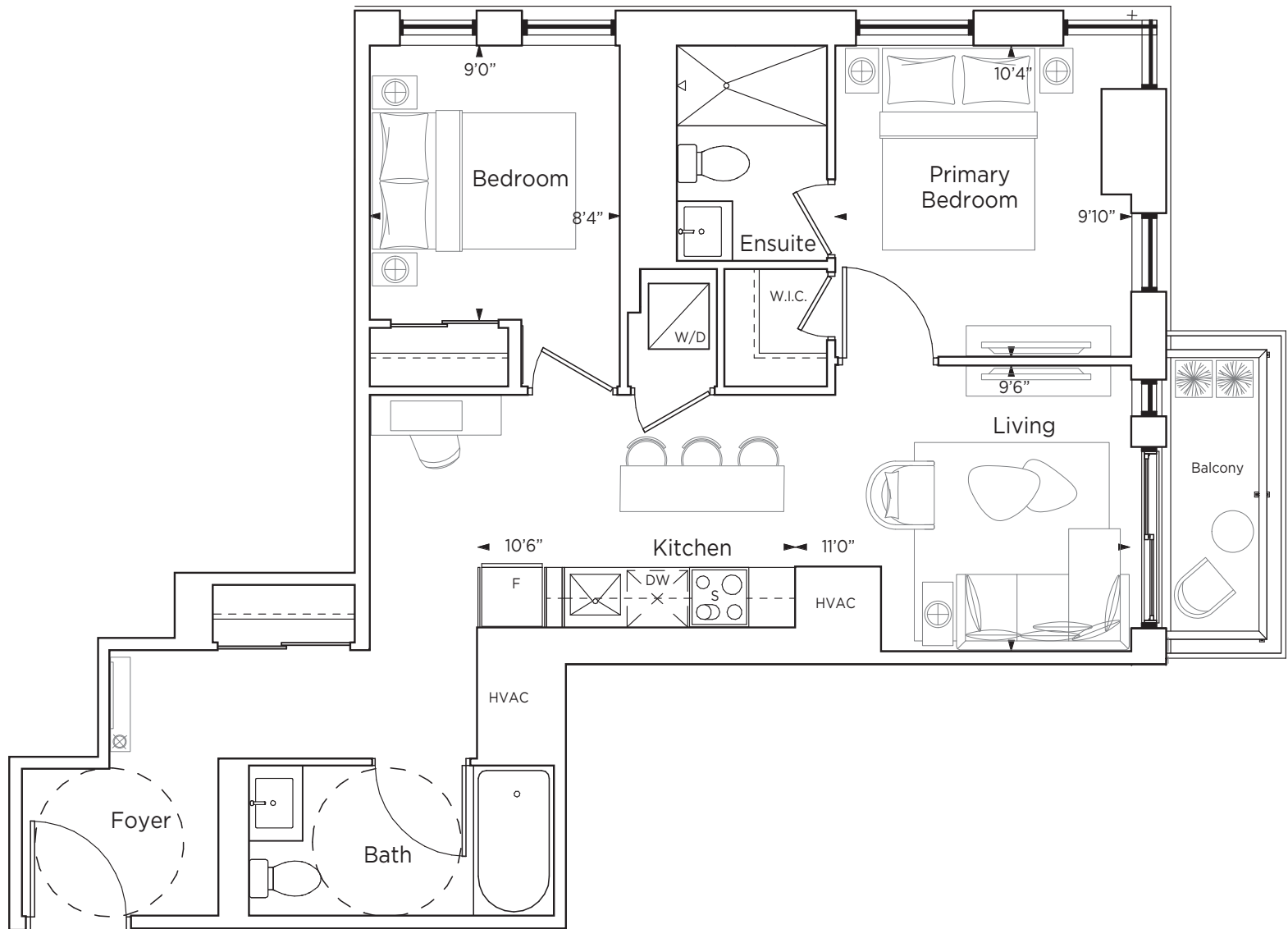

G11

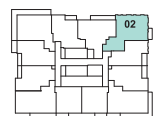

Tower A
LEVEL 15 - 34



Tower A
LEVEL 7 - 14



TWO BED

LOS ANGELES

699 SQ.FT. • 77 SQ.FT. BALCONY • 165 SQ.FT. TERRACE

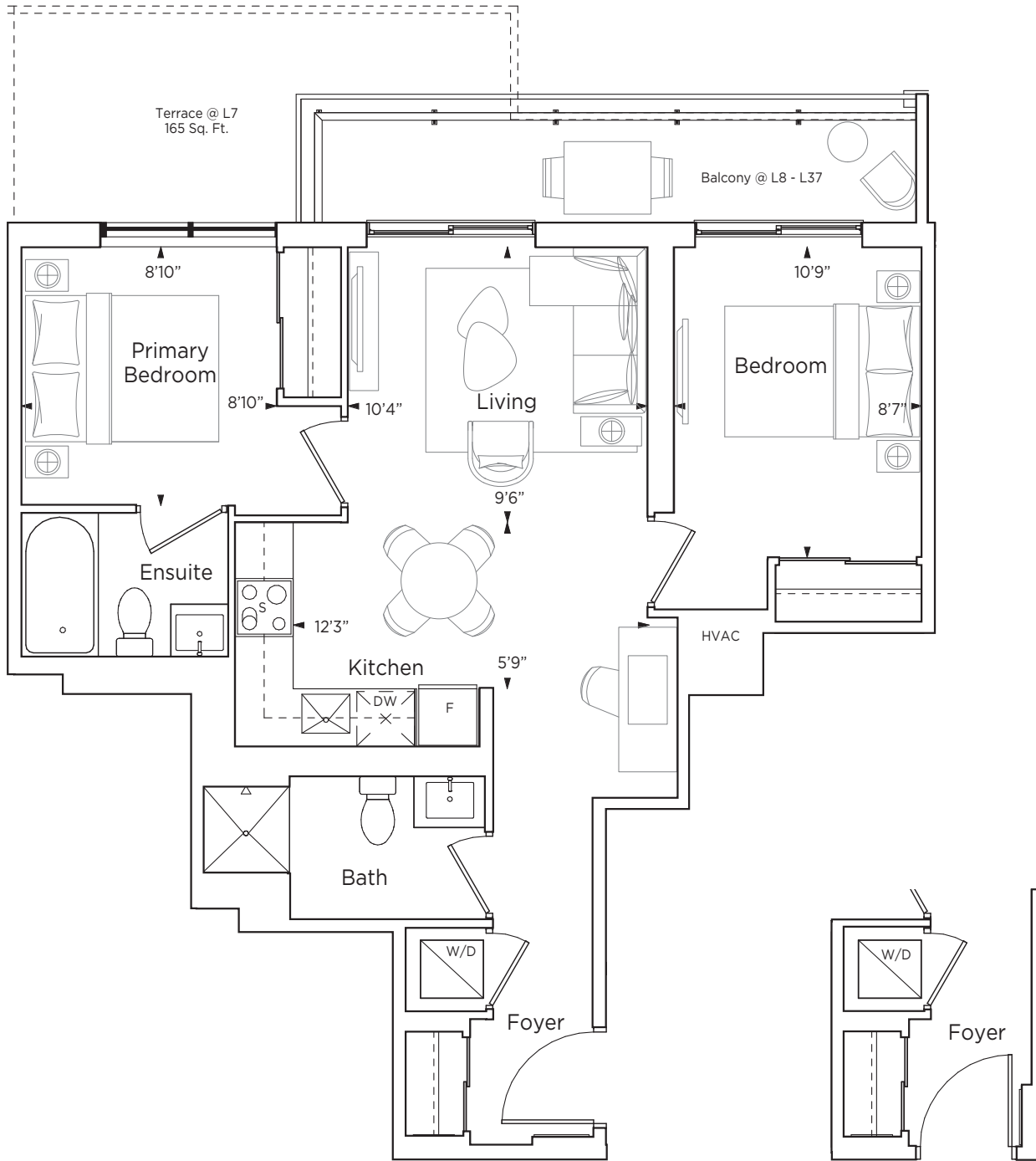

G12

ENTRANCE
AT LEVEL 35 - 37

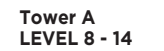

Vincent
CONDOMINIUMS



Materials, specifications and floor plans are subject to change. All renderings are artist's concept. All floor plans are approximate dimensions. Actual usable floor space may vary from stated floor area. Balcony/terrace areas may vary. Windows, room/area dimensions & square feet may vary due to location within building. Furniture not included. E. & O. E.

ONE BED (BARRIER-FREE)

CHAMPAGNE

518 SQ.FT. • 45 SQ.FT. BALCONY

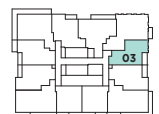
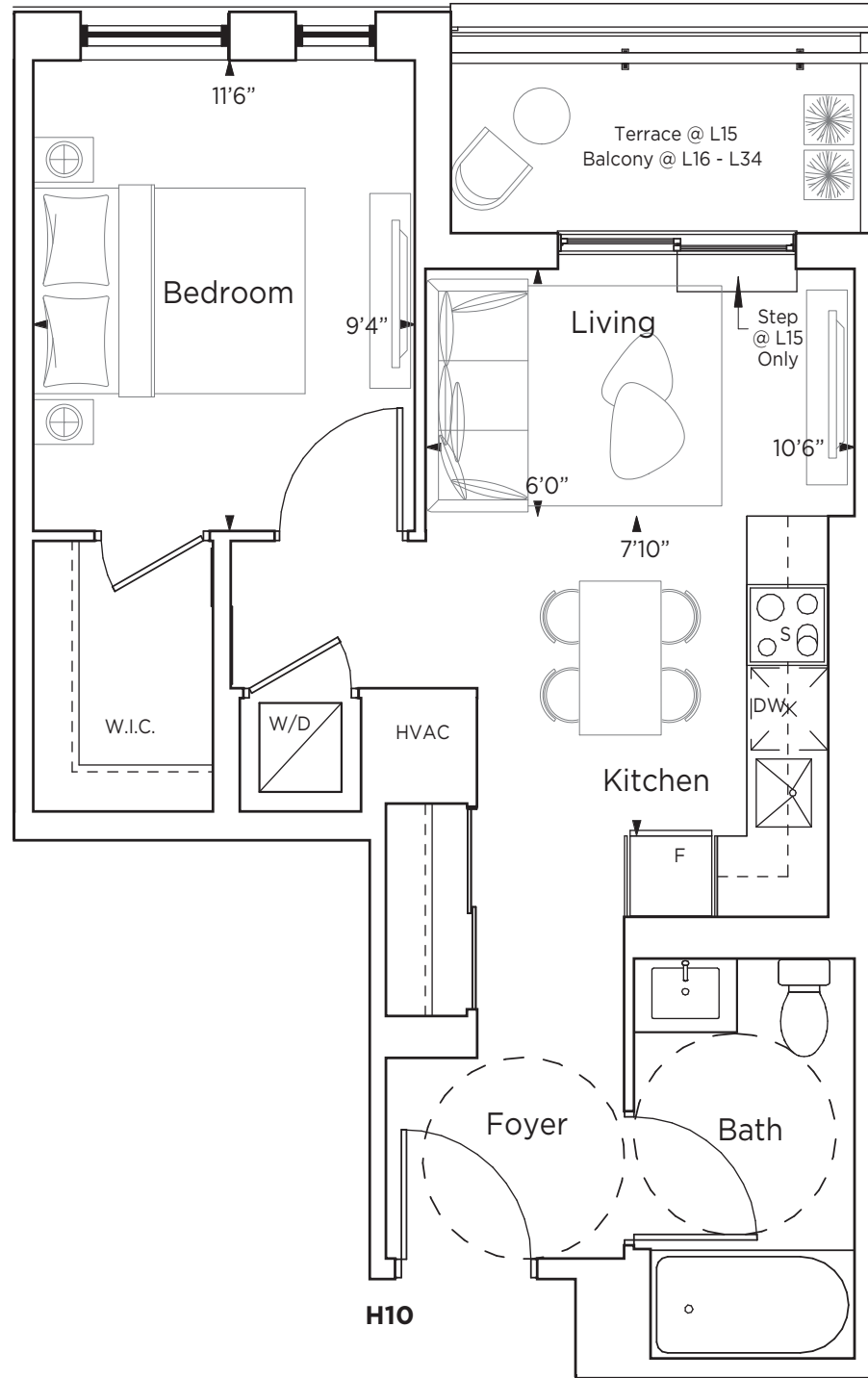

Tower A
LEVEL 15-34

ONE BED

COGNAC

528 SQ.FT. • 44 SQ.FT. BALCONY

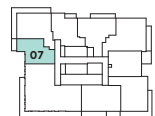
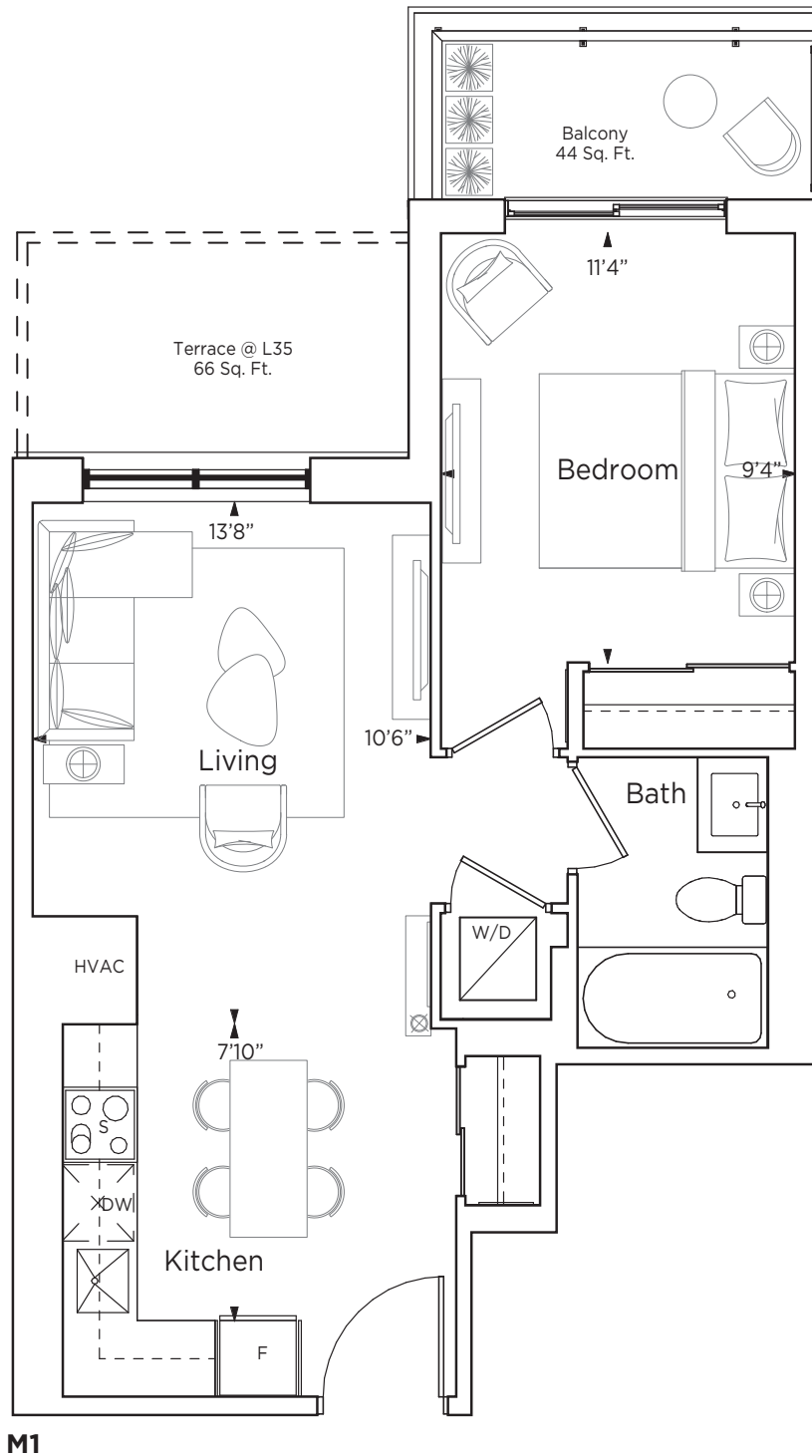

Tower A
LEVEL 36 - 37

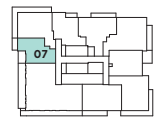

Tower A
LEVEL 35



Vincent
CONDOMINIUMS



THREE BED (BARRIER-FREE)

VIENNA

1489 SQ.FT. • 228 SQ.FT. BALCONY • 241 SQ.FT. TERRACE

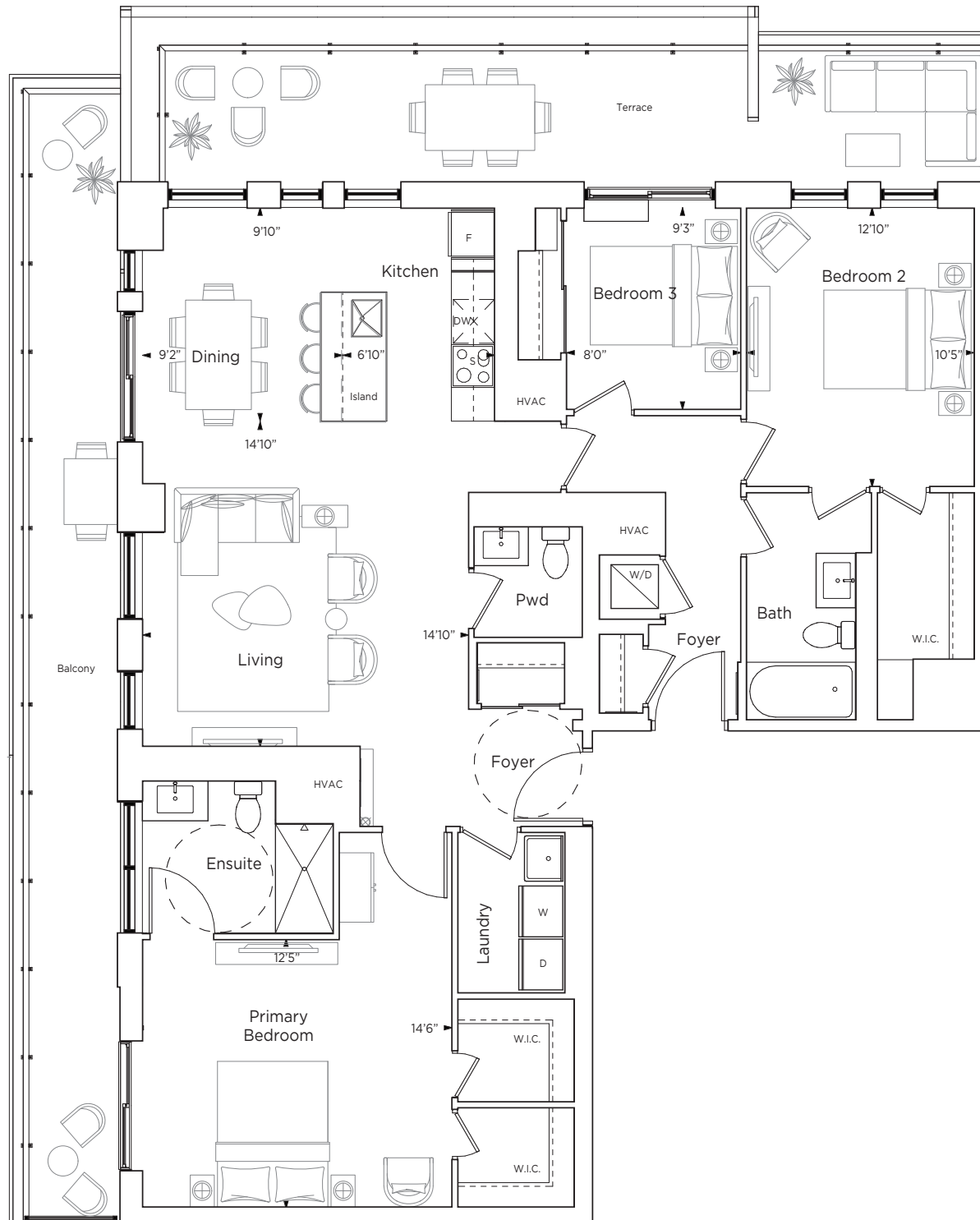

M2



Vincent
CONDOMINIUMS

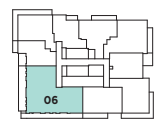

Tower A
LEVEL 35

Materials, specifications and floor plans are subject to change. All renderings are artist's concept. All floor plans are approximate dimensions. Actual usable floor space may vary from stated floor area. Balcony/terrace areas may vary. Windows, room/area dimensions & square feet may vary due to location within building. Furniture not included. E. & O. E.

THREE BED

VINCENT

1489 SQ.FT. • 353 SQ.FT. BALCONY

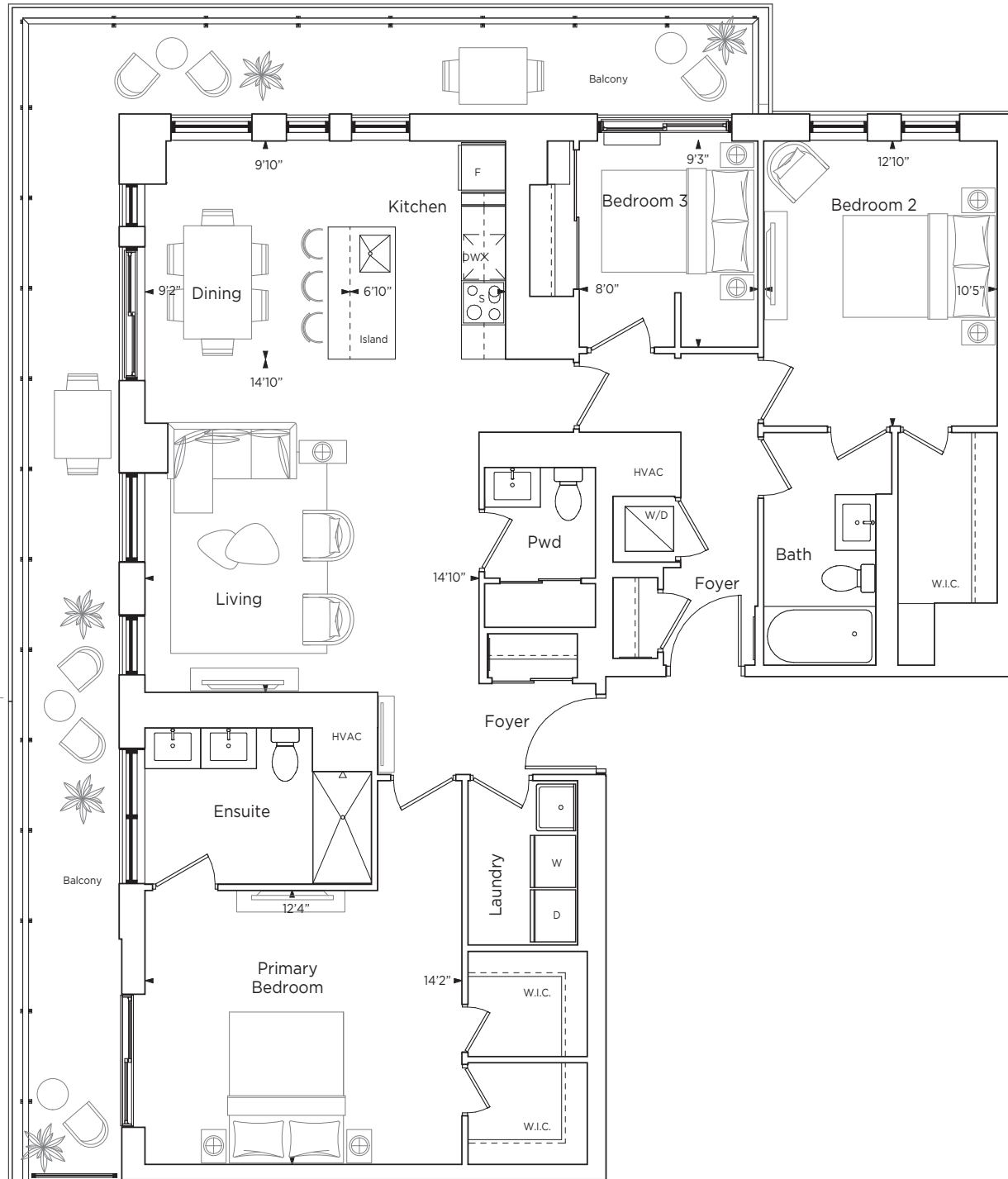

M3



Vincent
CONDOMINIUMS

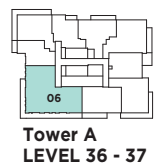

Materials, specifications and floor plans are subject to change. All renderings are artist's concept. All floor plans are approximate dimensions. Actual usable floor space may vary from stated floor area. Balcony/terrace areas may vary. Windows, room/area dimensions & square feet may vary due to location within building. Furniture not included. E. & O. E.

TWO BED

OMEGA

744 SQ.FT. • 177 SQ.FT. BALCONY

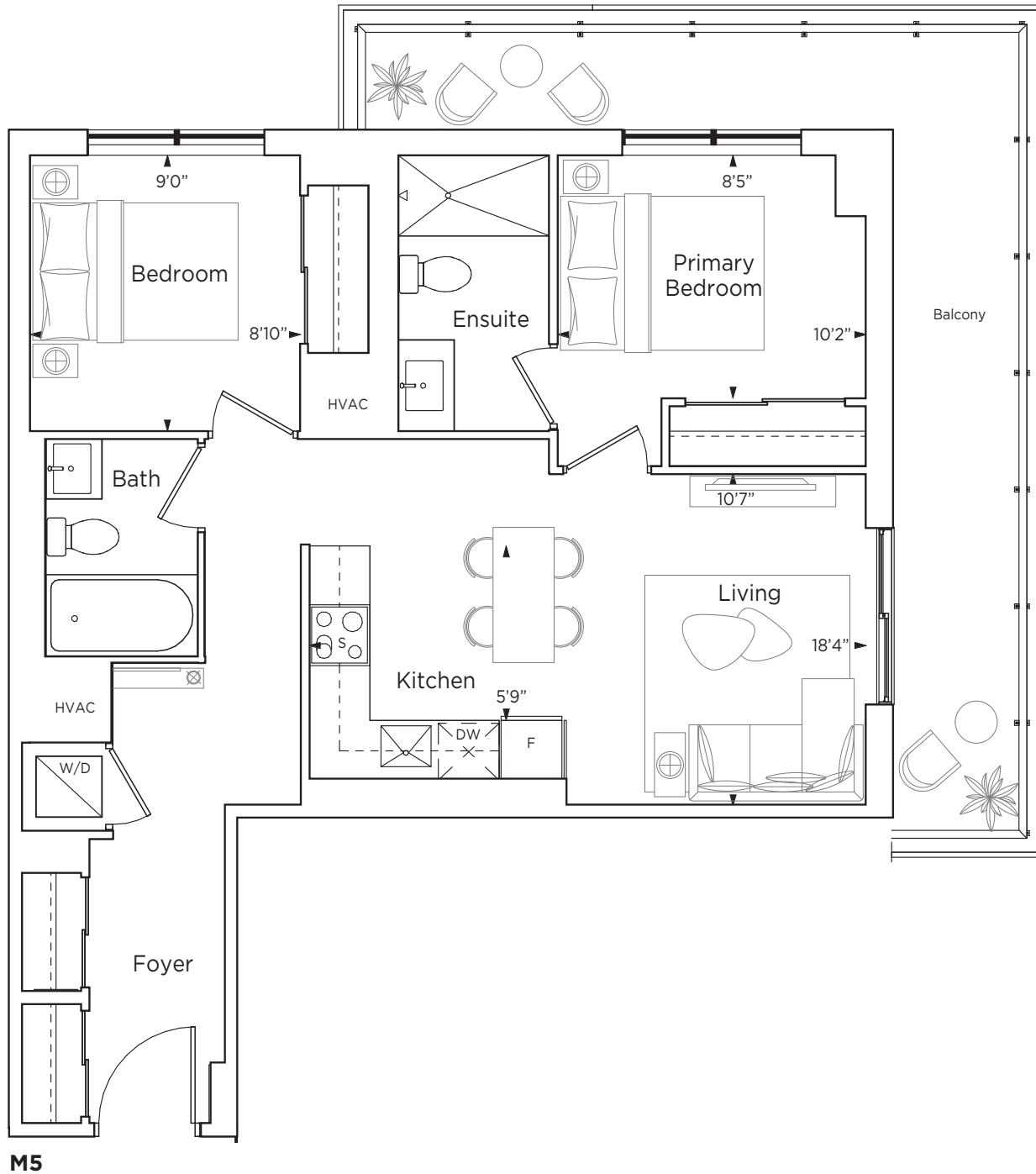

Vincent
CONDOMINIUMS

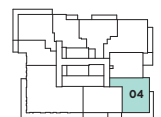

Tower A
LEVEL 35 - 37

Materials, specifications and floor plans are subject to change. All renderings are artist's concept. All floor plans are approximate dimensions. Actual usable floor space may vary from stated floor area. Balcony/terrace areas may vary. Windows, room/area dimensions & square feet may vary due to location within building. Furniture not included. E. & O. E.

ONE BED + DEN (BARRIER FREE)

HERRINGBONE

593 SQ.FT. • 85 SQ.FT. BALCONY

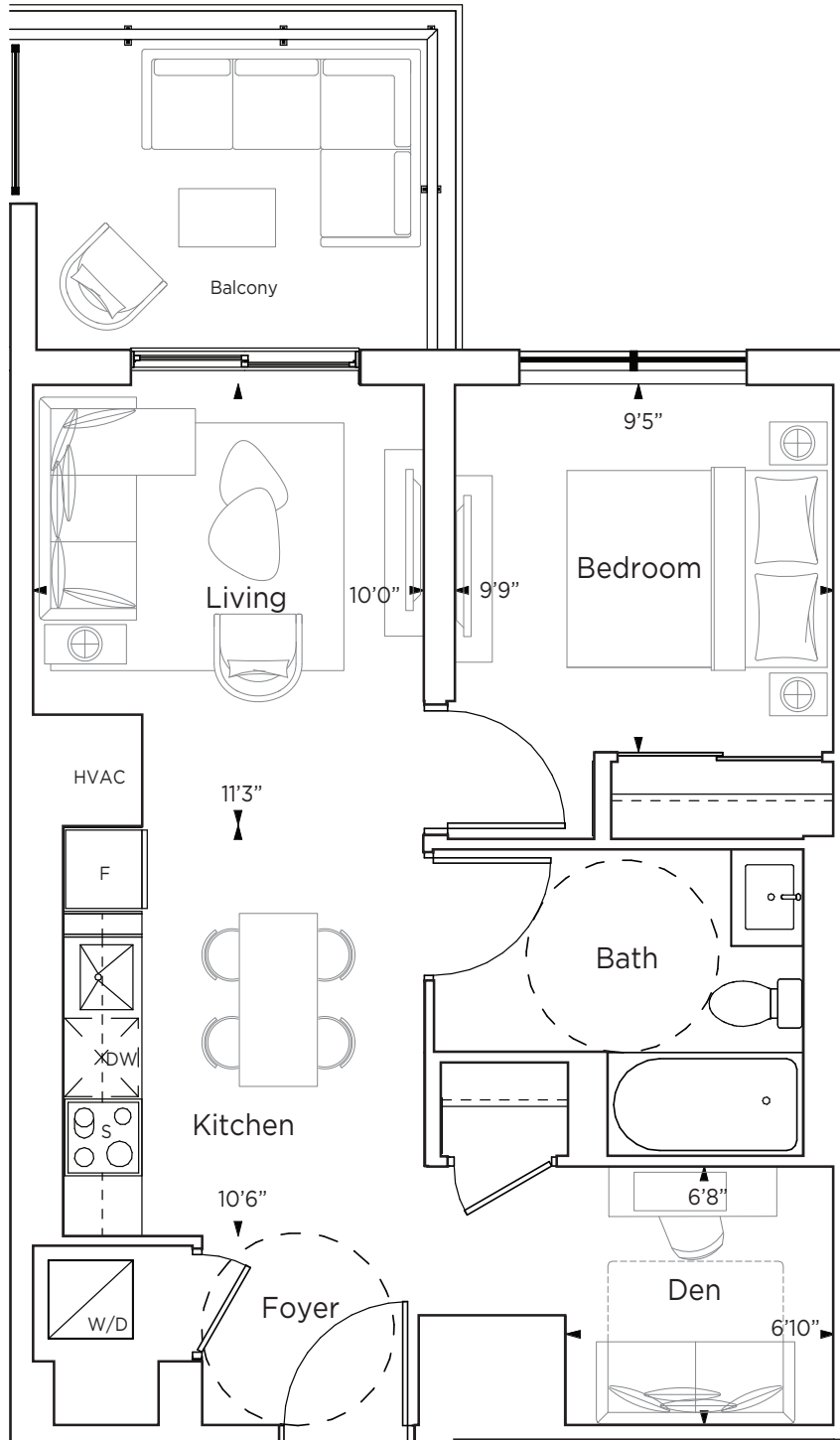

M6



Vincent
CONDOMINIUMS

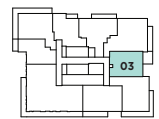

Tower A
LEVEL 35 - 37

Materials, specifications and floor plans are subject to change. All renderings are artist's concept. All floor plans are approximate dimensions. Actual usable floor space may vary from stated floor area. Balcony/terrace areas may vary. Windows, room/area dimensions & square feet may vary due to location within building. Furniture not included. E. & O. E.

TWO BED

TWEED

855 SQ.FT. • 92 SQ.FT. BALCONY

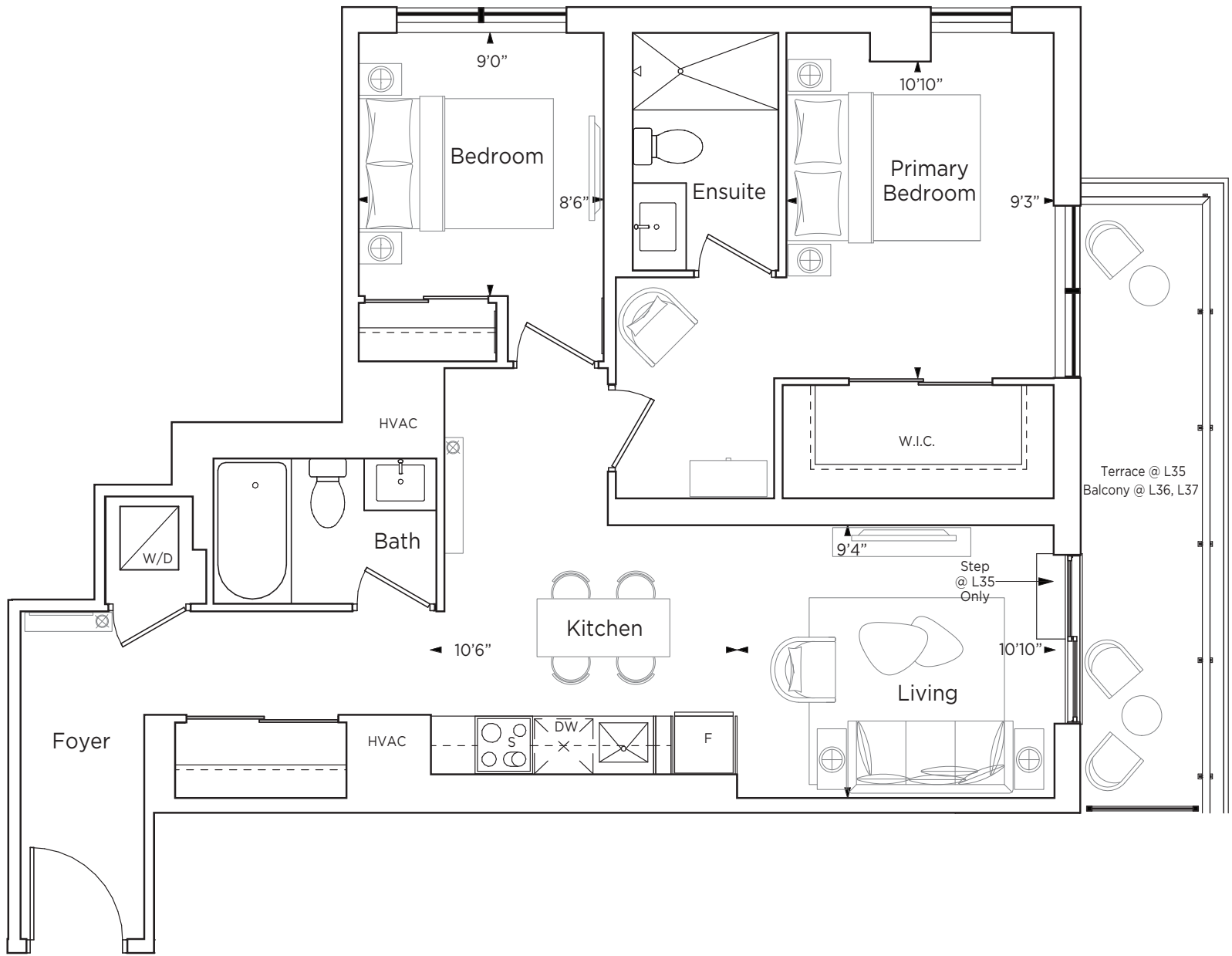

M7



Vincent
CONDOMINIUMS

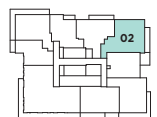

Tower A
LEVEL 35 - 37

Materials, specifications and floor plans are subject to change. All renderings are artist's concept. All floor plans are approximate dimensions. Actual usable floor space may vary from stated floor area. Balcony/terrace areas may vary. Windows, room/area dimensions & square feet may vary due to location within building. Furniture not included. E. & O. E.

Tower B

ONE BED + DEN (BARRIER FREE)

LONDON

669 SQ.FT. • 51 SQ.FT. BALCONY

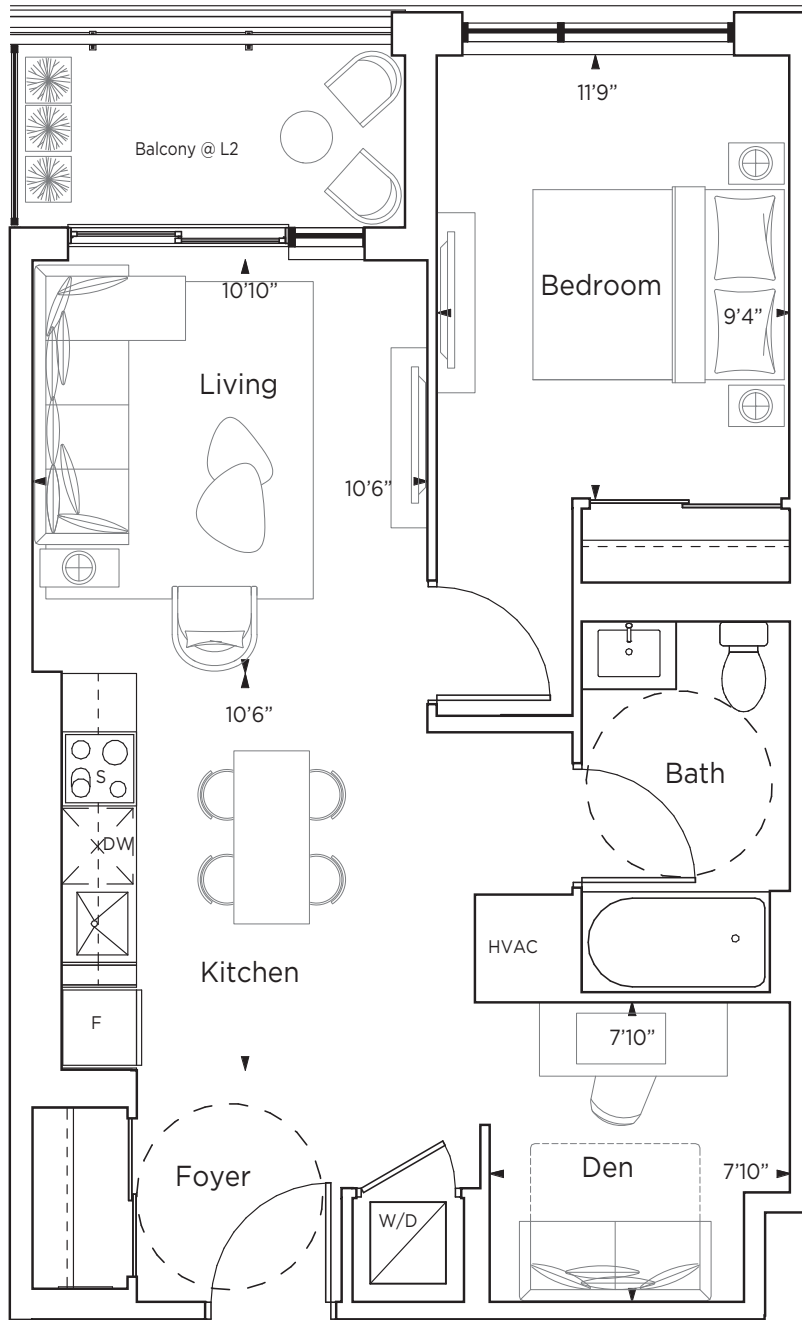

A2

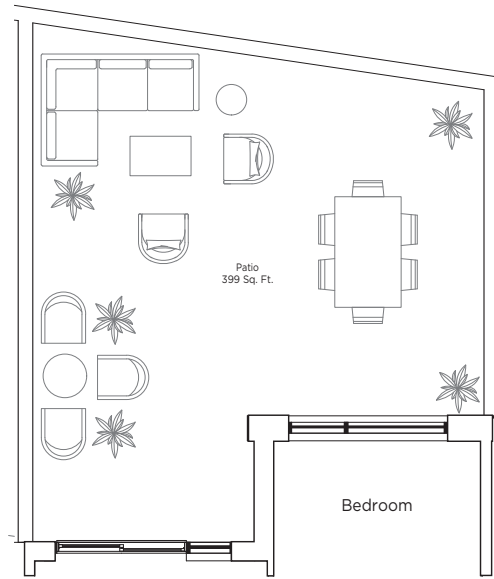

PATIO PLAN
A2 - 2 AT LEVEL 1

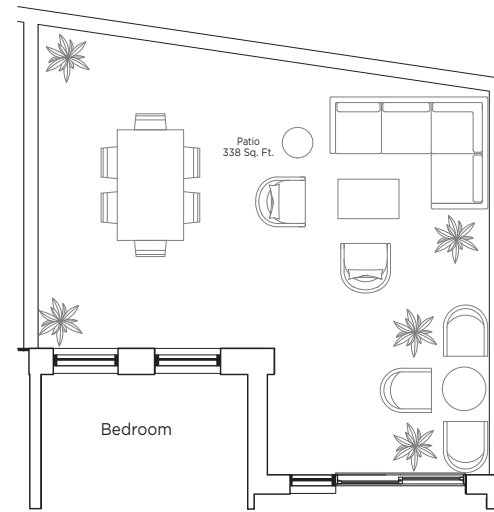

PATIO PLAN
A2 - 1 AT LEVEL 1

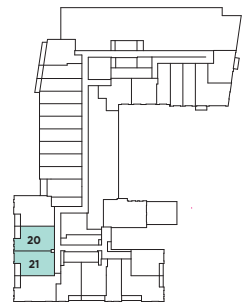

Tower B
LEVEL 2

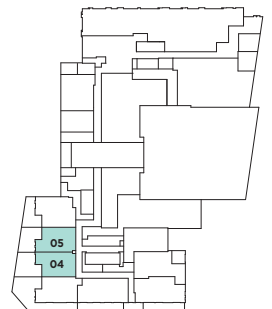

Tower B
LEVEL 1



Vincent
CONDOMINIUMS



Materials, specifications and floor plans are subject to change. All renderings are artist's concept. All floor plans are approximate dimensions. Actual usable floor space may vary from stated floor area. Balcony/terrace areas may vary. Windows, room/area dimensions & square feet may vary due to location within building. Furniture not included. E. & O. E.

TWO BED

PRAGUE

770 SQ.FT. • 51 SQ.FT. BALCONY @ LEVEL 2
752 SQ.FT. • 749 SQ.FT. TERRACE @ LEVEL 1

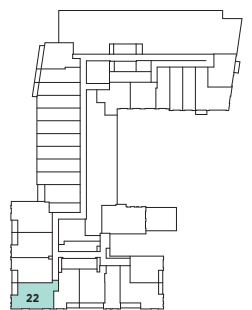
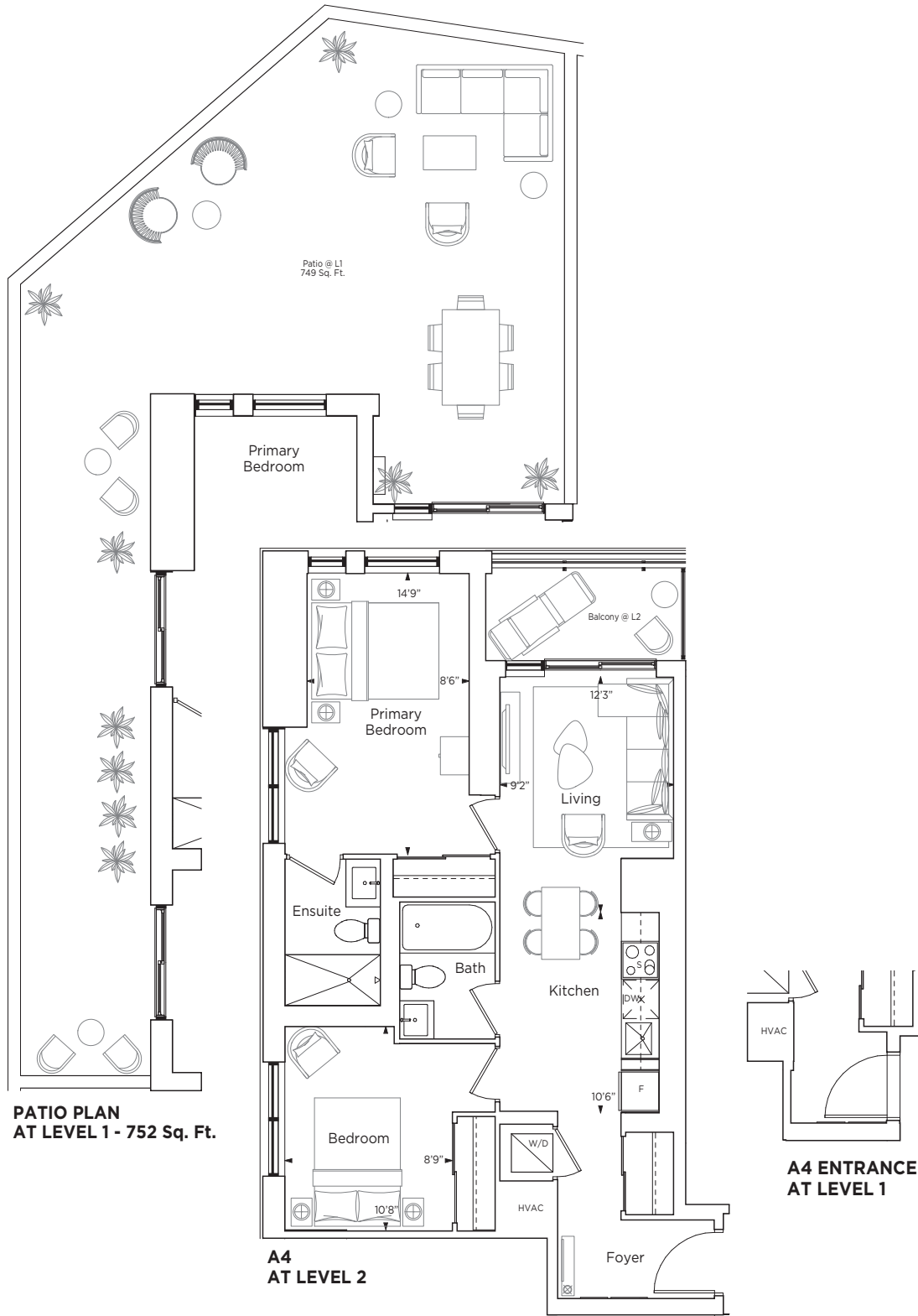

Tower B
LEVEL 2

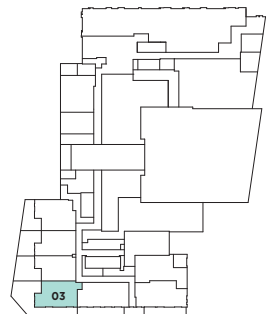

Tower B
LEVEL 1



Vincent
CONDOMINIUMS



TWO BED

VANQUISH

875 SQ.FT. • 273 SQ.FT. PATIO

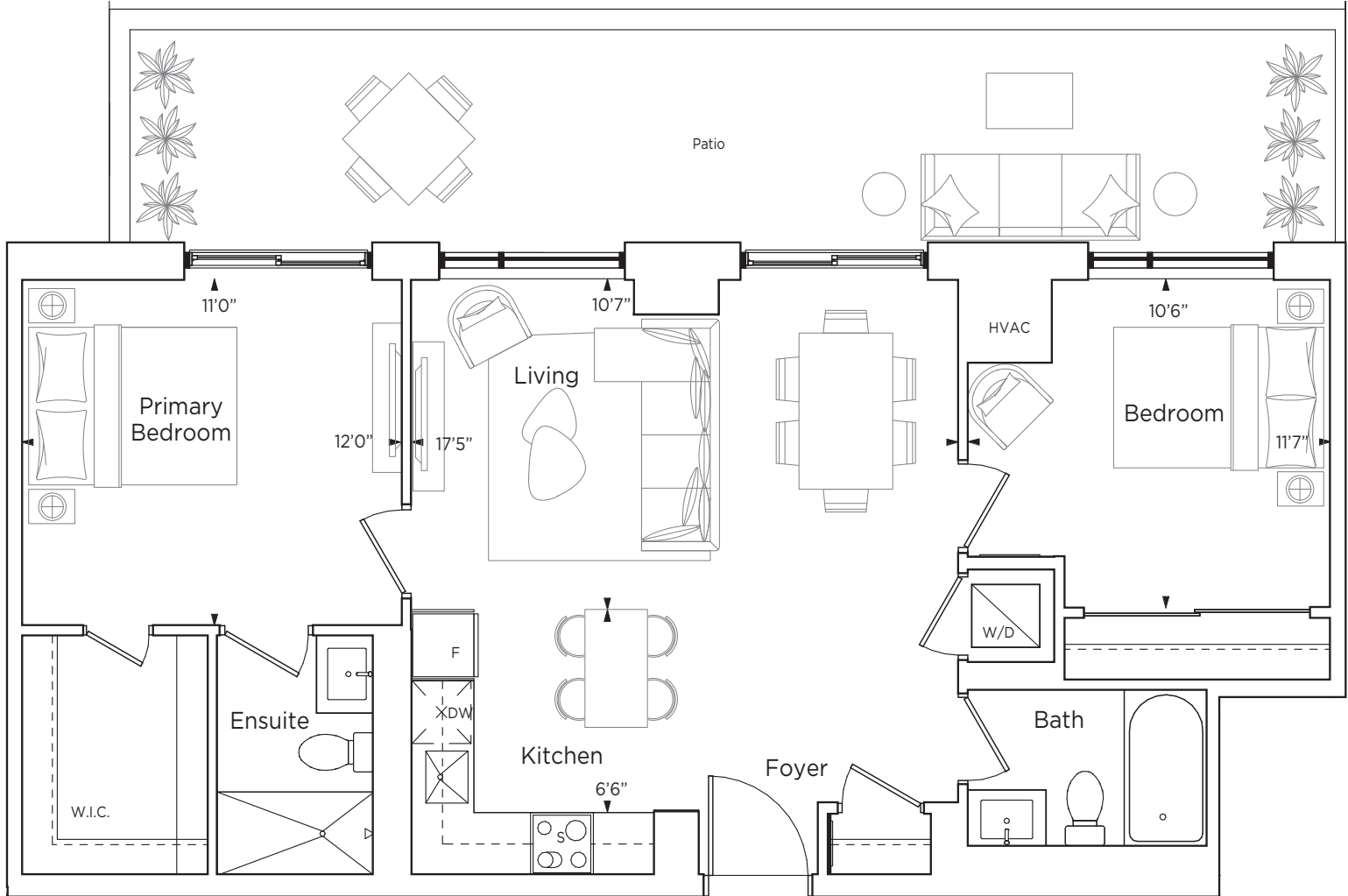

Materials, specifications and floor plans are subject to change. All renderings are artist's concept. All floor plans are approximate dimensions. Actual usable floor space may vary from stated floor area. Balcony/terrace areas may vary. Windows, room/area dimensions & square feet may vary due to location within building. Furniture not included. E. & O. E.

TWO BED

VENICE

879 SQ.FT. • 245 SQ.FT. PATIO

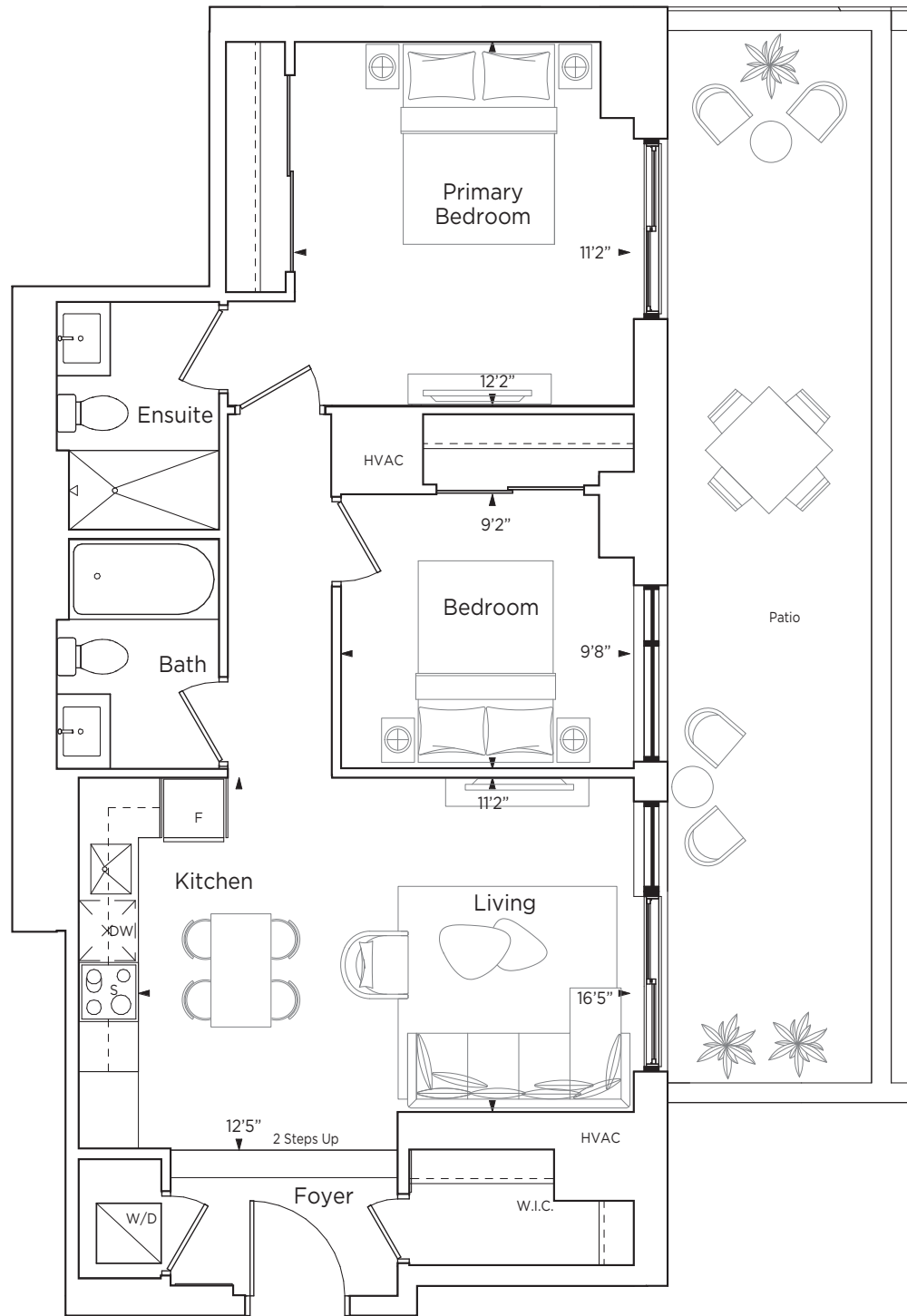

A6

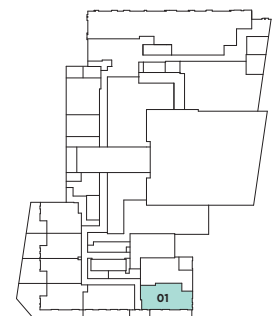

Tower B
LEVEL 1



Vincent
CONDOMINIUMS



TWO BED

SOVEREIGN

821 SQ.FT. • 51 SQ.FT. BALCONY

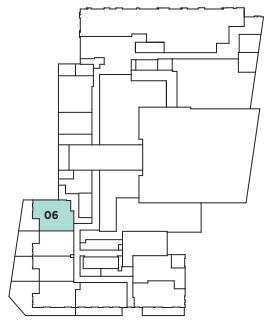
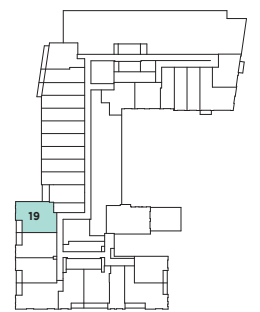
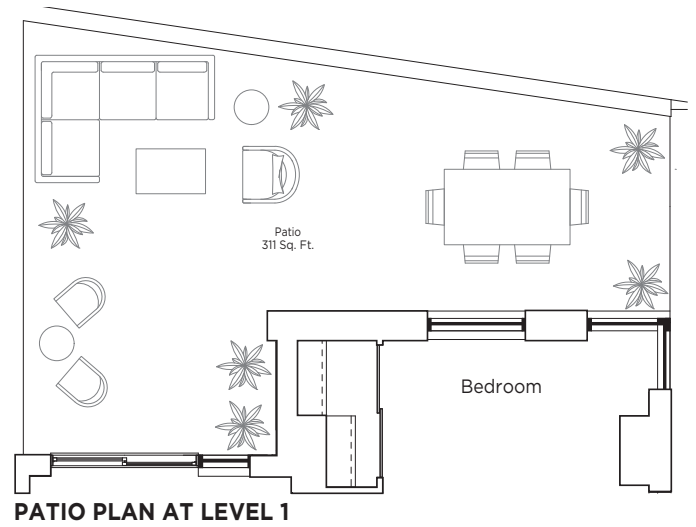
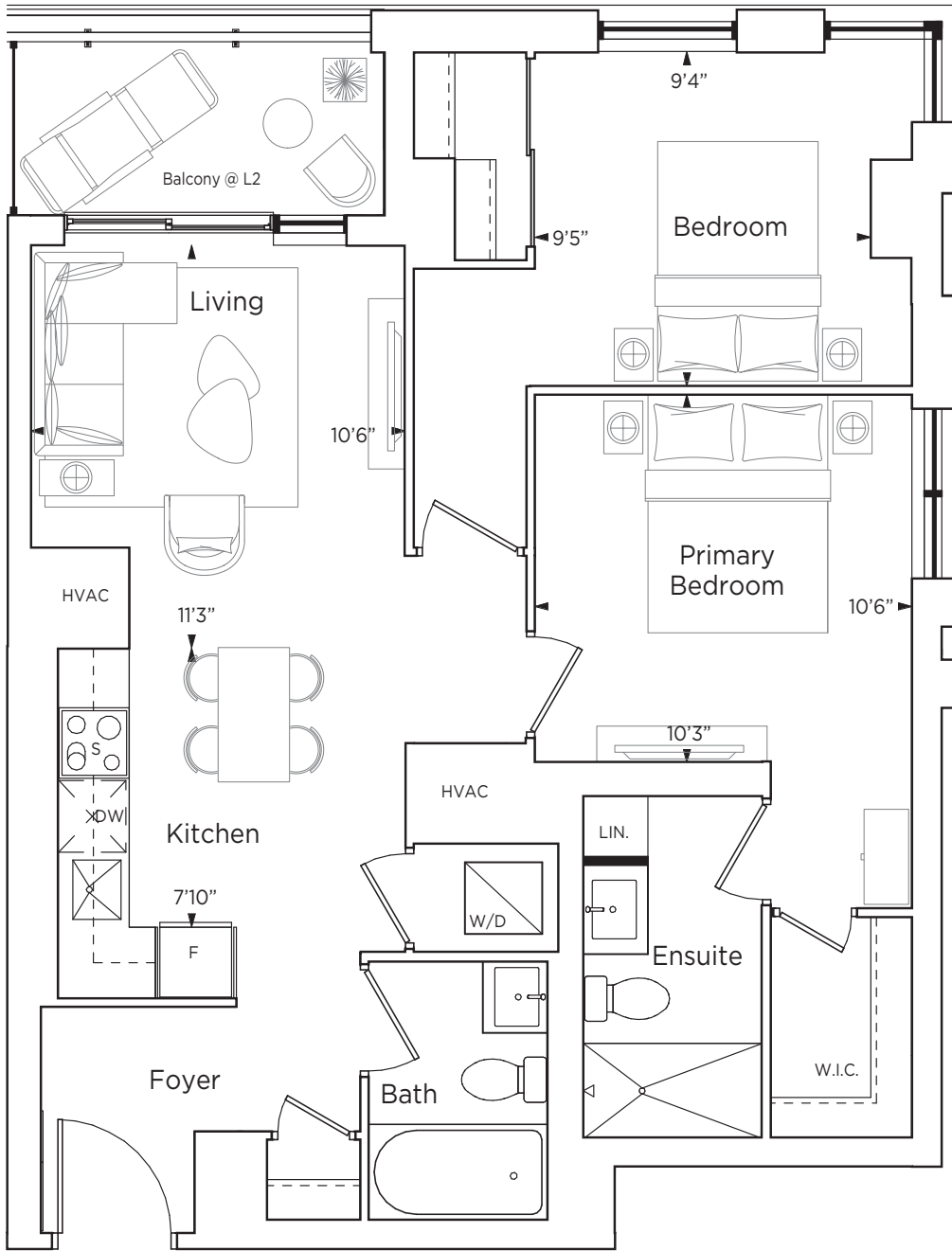

Materials, specifications and floor plans are subject to change. All renderings are artist's concept. All floor plans are approximate dimensions. Actual usable floor space may vary from stated floor area. Balcony/terrace areas may vary. Windows, room/area dimensions & square feet may vary due to location within building. Furniture not included. E. & O. E.

ONE BED + DEN

GLENCOE

583 SQ.FT. • 45 SQ.FT. BALCONY

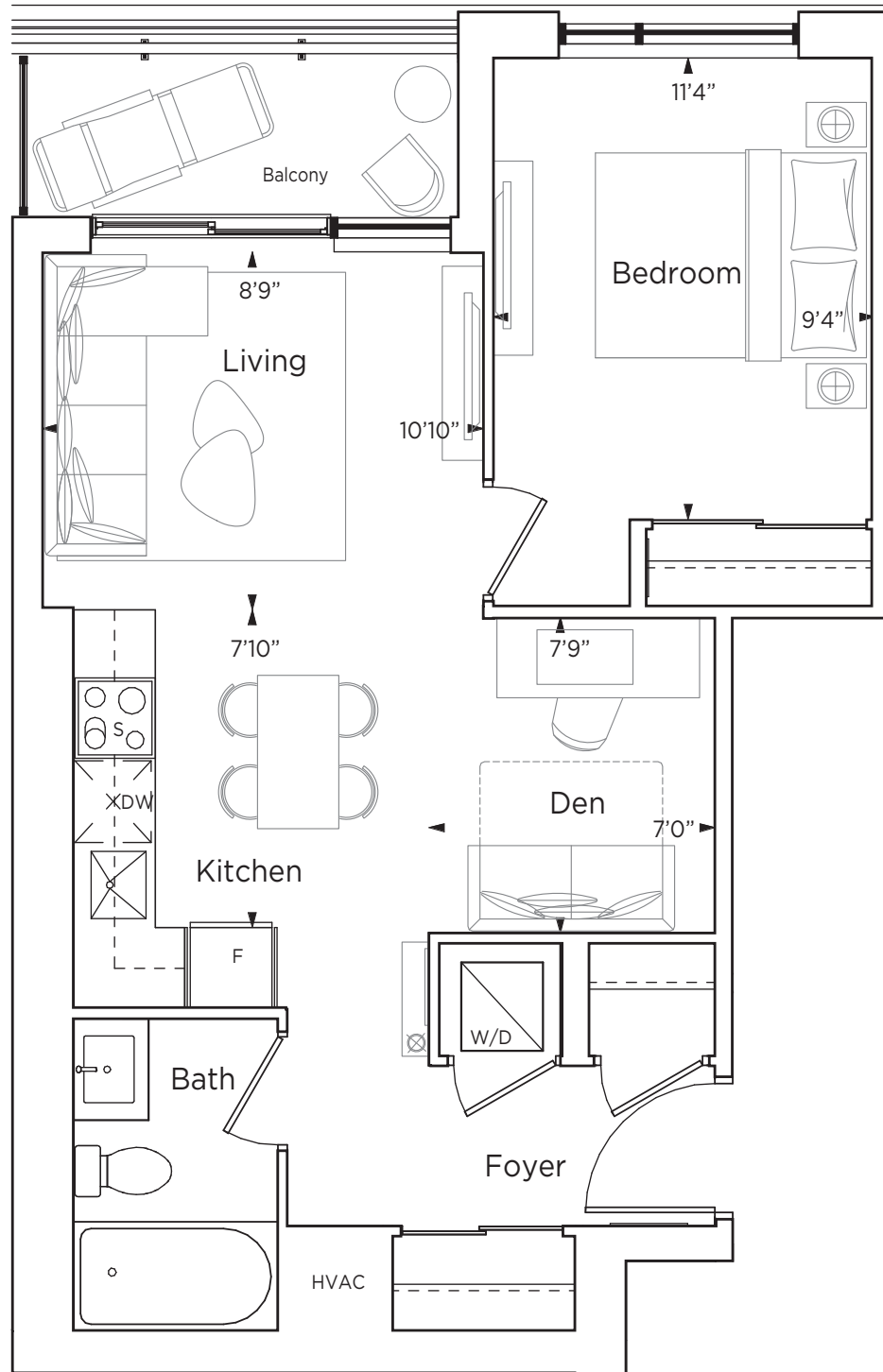

B16

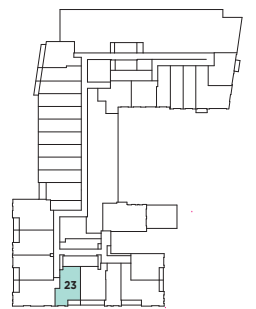

Tower B
LEVEL 2



Vincent
CONDOMINIUMS



ONE BED + DEN

LAKE COMO

624 SQ.FT. • 84 SQ.FT. BALCONY

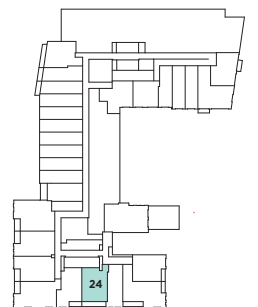
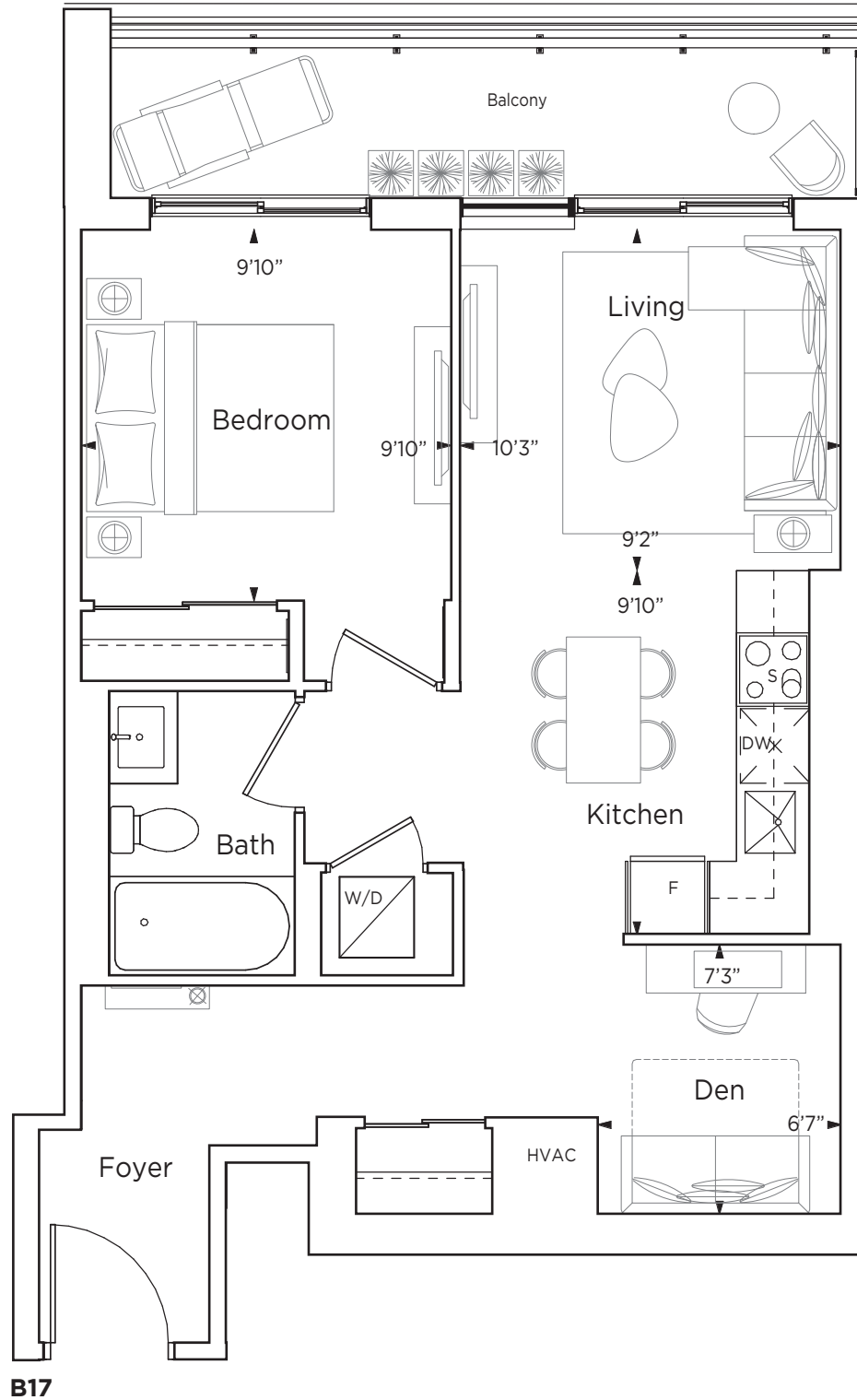

Vincent
CONDOMINIUMS



Tower B
LEVEL 2

Materials, specifications and floor plans are subject to change. All renderings are artist's concept. All floor plans are approximate dimensions. Actual usable floor space may vary from stated floor area. Balcony/terrace areas may vary. Windows, room/area dimensions & square feet may vary due to location within building. Furniture not included. E. & O. E.

STUDIO (BARRIER-FREE)

BRIDGE

463 SQ.FT.

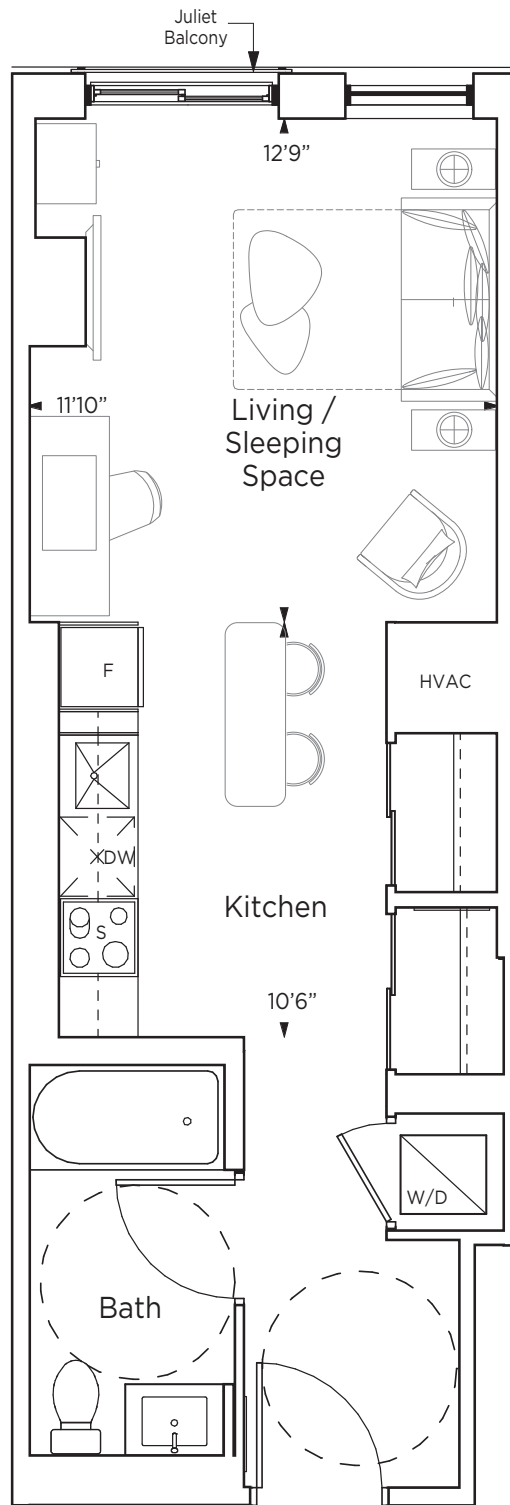

B18

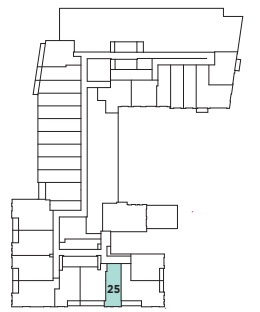

Tower B
LEVEL 2



Vincent
CONDOMINIUMS



Materials, specifications and floor plans are subject to change. All renderings are artist's concept. All floor plans are approximate dimensions. Actual usable floor space may vary from stated floor area. Balcony/terrace areas may vary. Windows, room/area dimensions & square feet may vary due to location within building. Furniture not included. E. & O. E.

TWO BED

ROULETTE

791 SQ.FT. • 71 SQ.FT. BALCONY • 33 SQ.FT. TERRACE

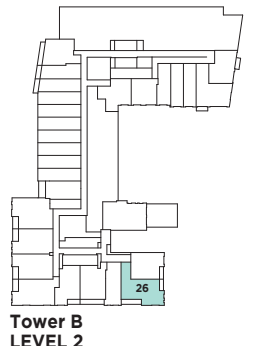
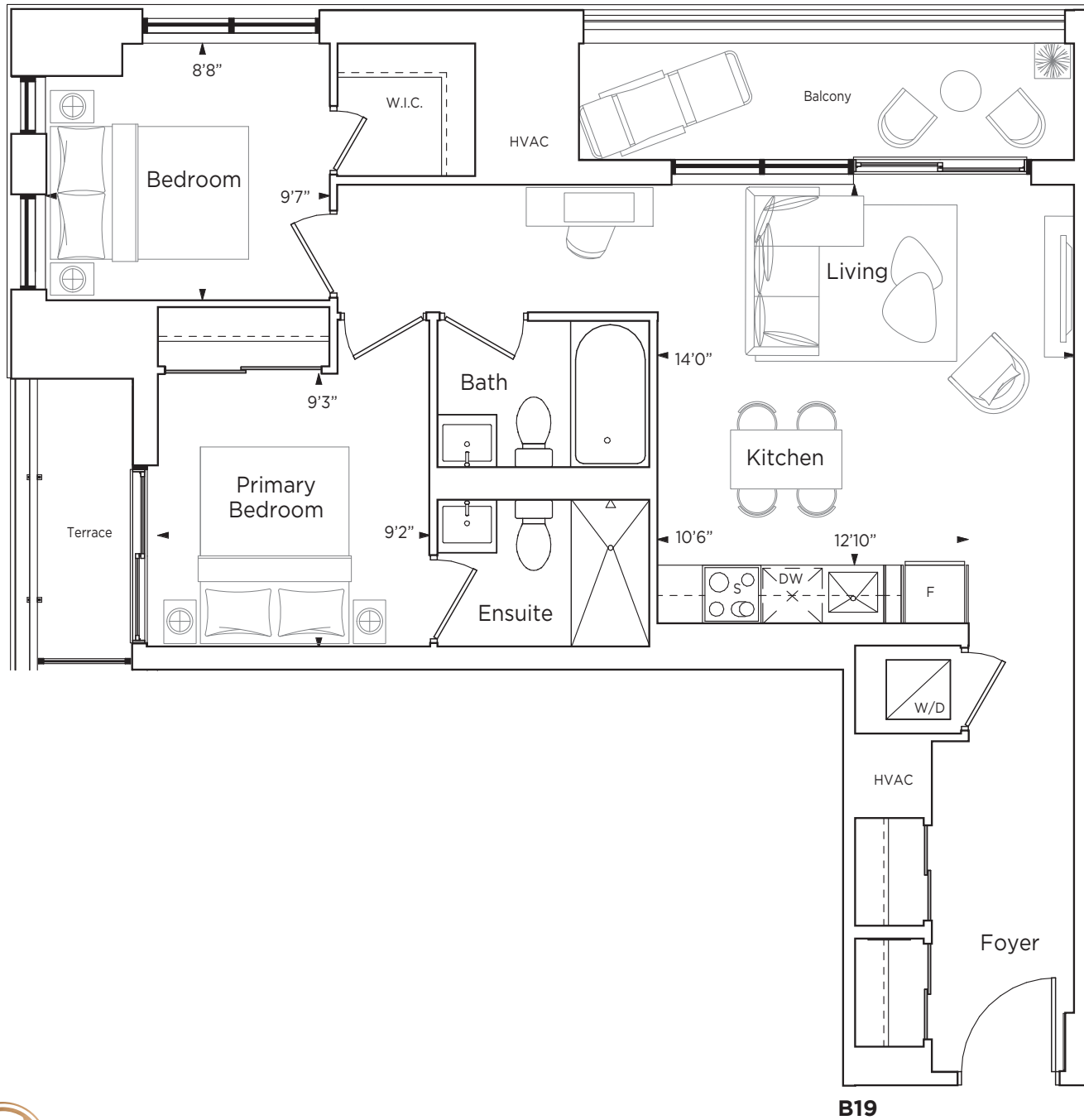

Materials, specifications and floor plans are subject to change. All renderings are artist's concept. All floor plans are approximate dimensions. Actual usable floor space may vary from stated floor area. Balcony/terrace areas may vary. Windows, room/area dimensions & square feet may vary due to location within building. Furniture not included. E. & O. E.

ONE BED + DEN

GROSVENOR

584 SQ.FT. • 35 SQ.FT. TERRACE

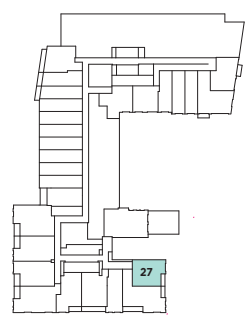
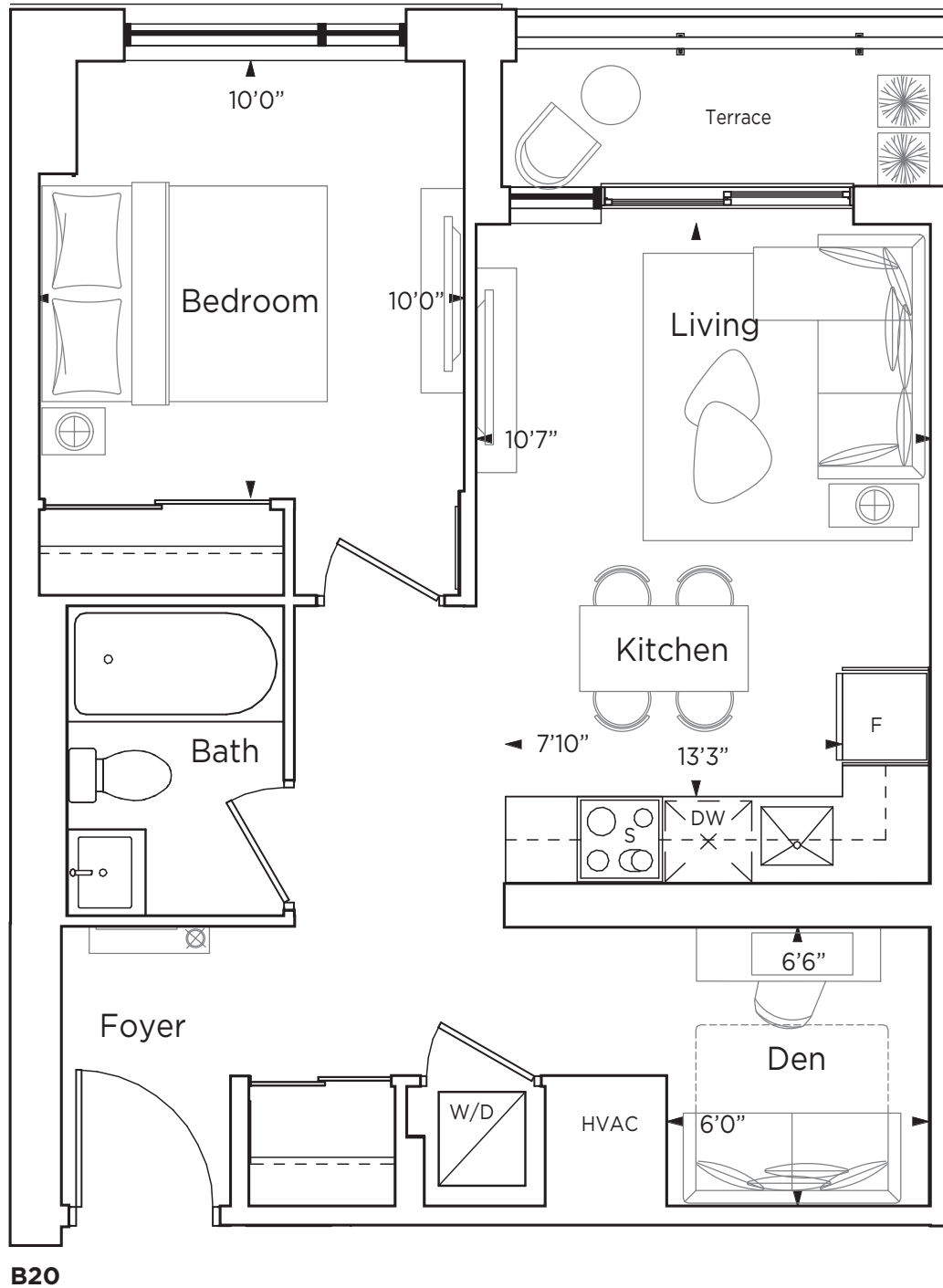

Tower B
LEVEL 2

Materials, specifications and floor plans are subject to change. All renderings are artist's concept. All floor plans are approximate dimensions. Actual usable floor space may vary from stated floor area. Balcony/terrace areas may vary. Windows, room/area dimensions & square feet may vary due to location within building. Furniture not included. E. & O. E.

TWO BED

VALLETTA

867 SQ.FT. • 504 SQ.FT. TERRACE

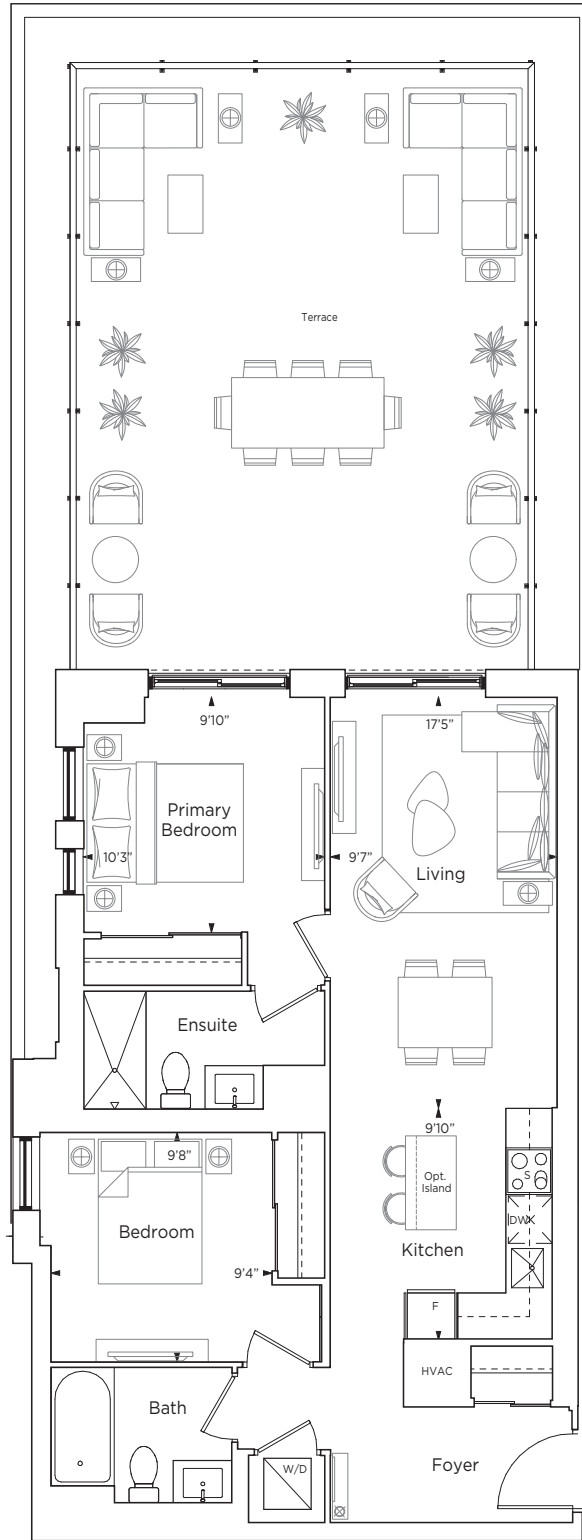

B21

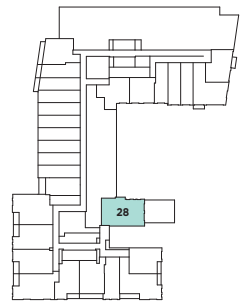

Tower B
LEVEL 2



Vincent
CONDOMINIUMS



Materials, specifications and floor plans are subject to change. All renderings are artist's concept. All floor plans are approximate dimensions. Actual usable floor space may vary from stated floor area. Balcony/terrace areas may vary. Windows, room/area dimensions & square feet may vary due to location within building. Furniture not included. E. & O. E.

STUDIO (BARRIER-FREE)

BRANDY

461 SQ.FT. • 82 SQ.FT. TERRACE

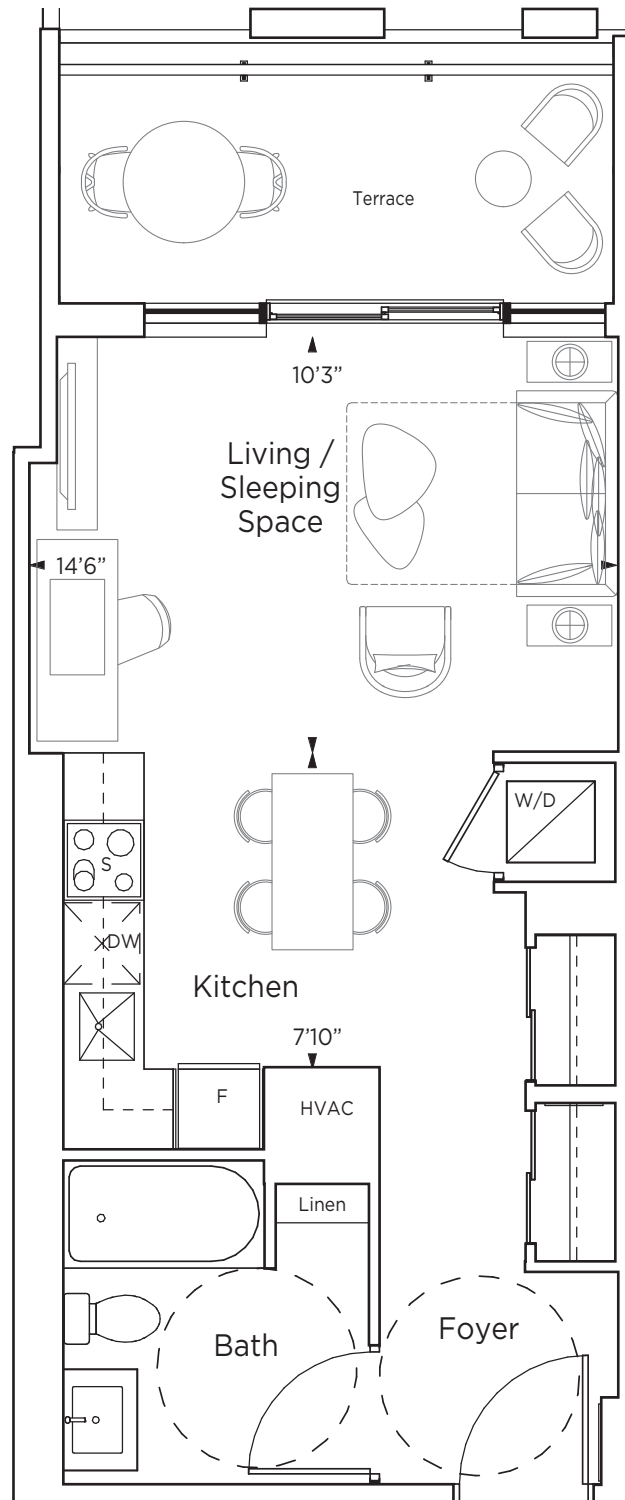

B22

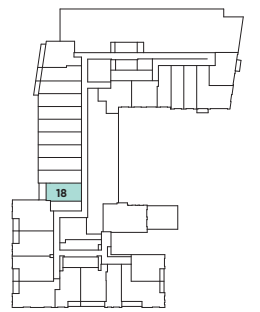

Tower B
LEVEL 2

ONE BED + DEN

KOBE

615 SQ.FT. • 59 SQ.FT. TERRACE

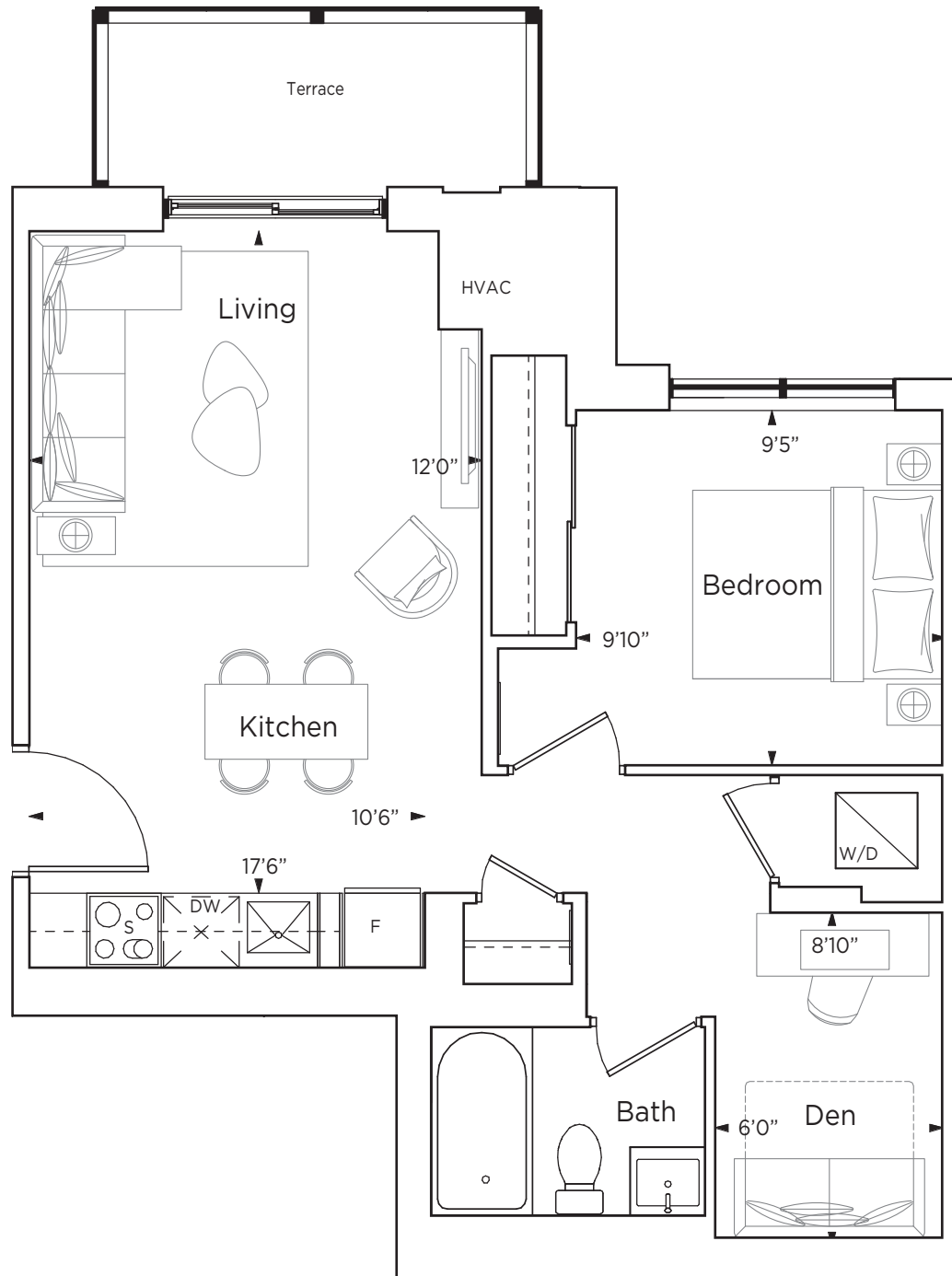

C17

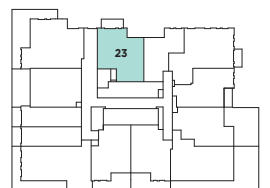

Tower B
LEVEL 3



Vincent
CONDOMINIUMS



Materials, specifications and floor plans are subject to change. All renderings are artist's concept. All floor plans are approximate dimensions. Actual usable floor space may vary from stated floor area. Balcony/terrace areas may vary. Windows, room/area dimensions & square feet may vary due to location within building. Furniture not included. E. & O. E.

STUDIO

ALPINE

346 SQ.FT. C20-2 • 53 SQ.FT. TERRACE

343 SQ.FT. C20-1 • 53 SQ.FT. TERRACE

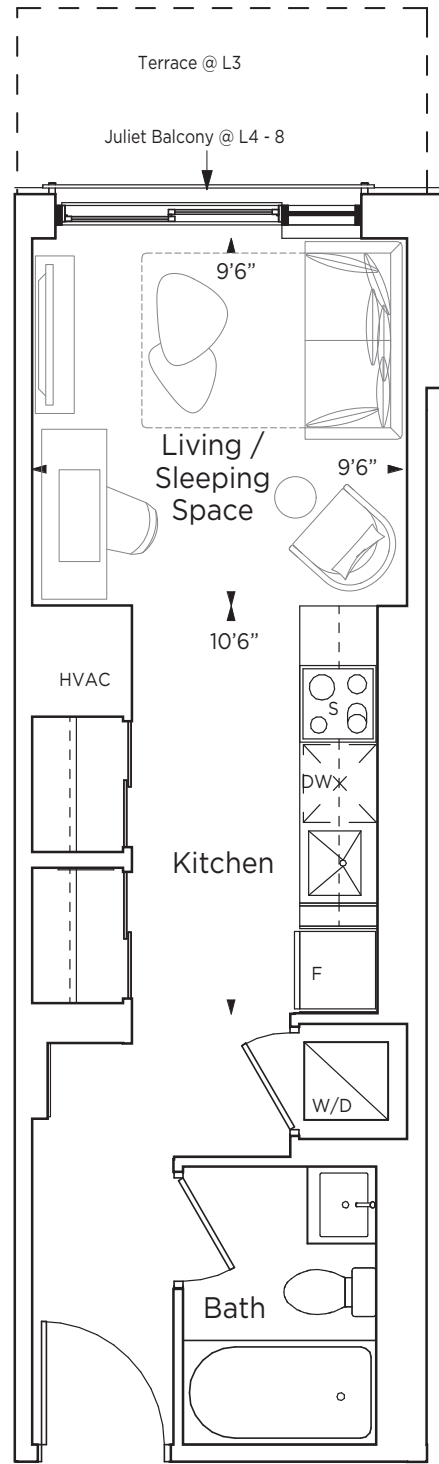

C20-2

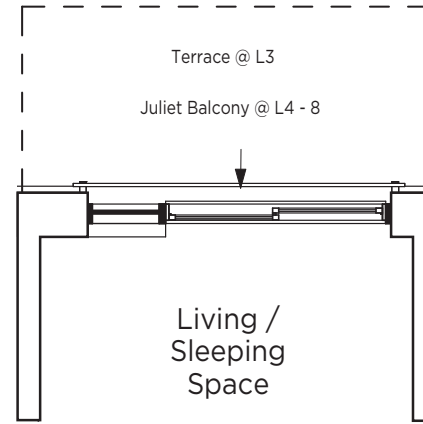

C20-1

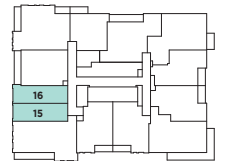

**Tower B
LEVEL 7 - 8**

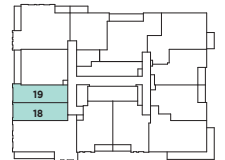

**Tower B
LEVEL 6**

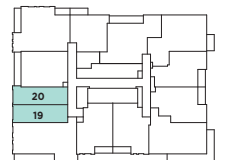

**Tower B
LEVEL 5**

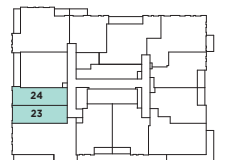

**Tower B
LEVEL 4**

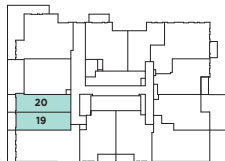

**Tower B
LEVEL 3**



Vincent
CONDOMINIUMS



Materials, specifications and floor plans are subject to change. All renderings are artist's concept. All floor plans are approximate dimensions. Actual usable floor space may vary from stated floor area. Balcony/terrace areas may vary. Windows, room/area dimensions & square feet may vary due to location within building. Furniture not included. E. & O. E.

TWO BED

SAN MARCO

792 SQ.FT. • 237 SQ.FT. TERRACE • 94 SQ.FT. BALCONY

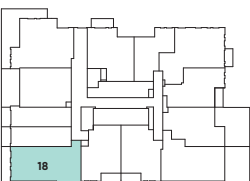
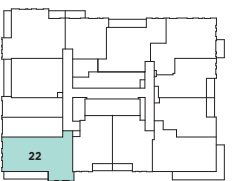
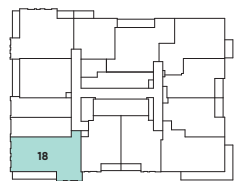
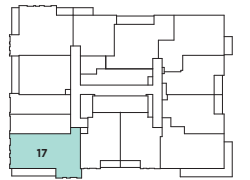
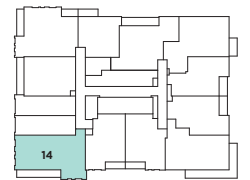
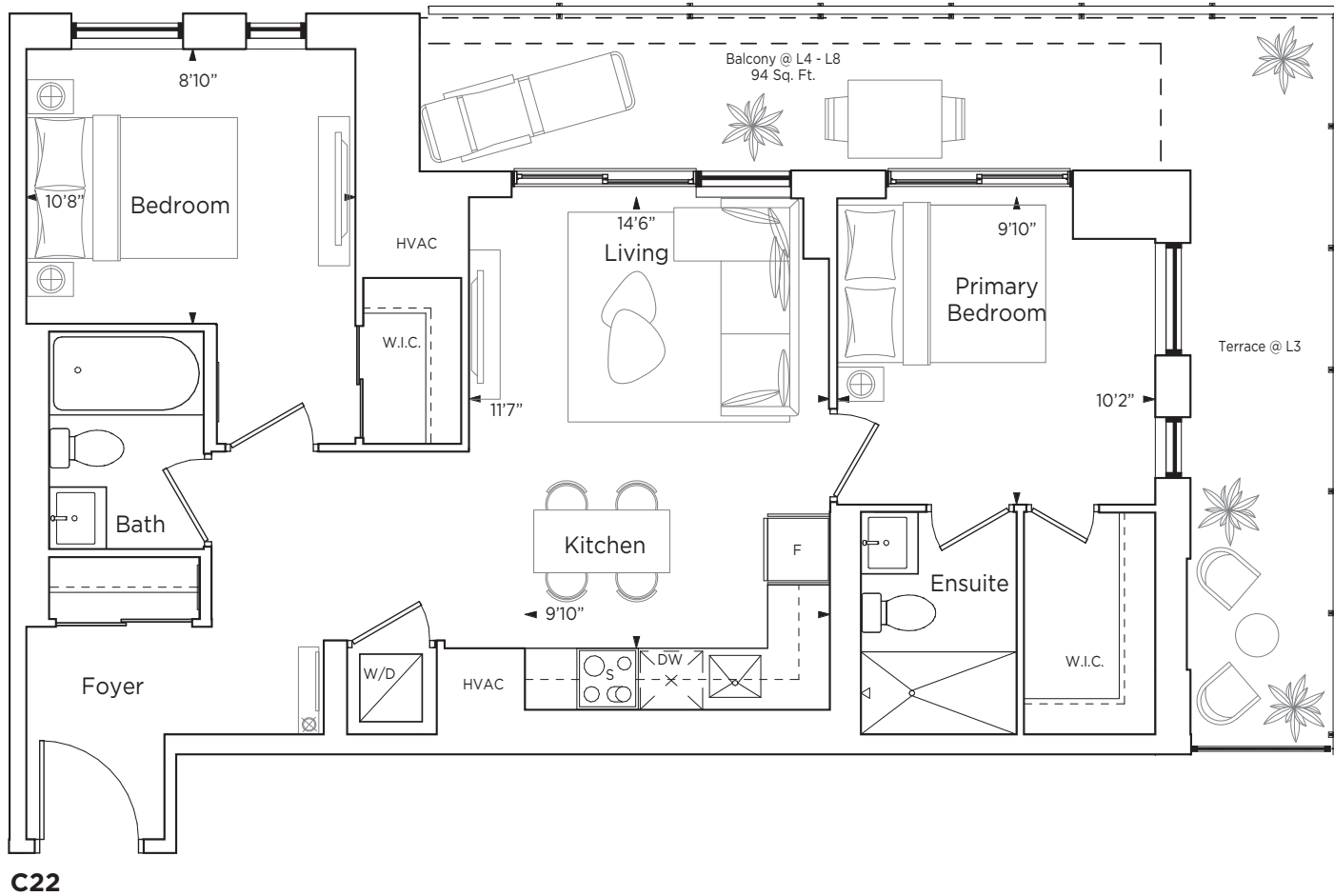

Materials, specifications and floor plans are subject to change. All renderings are artist's concept. All floor plans are approximate dimensions. Actual usable floor space may vary from stated floor area. Balcony/terrace areas may vary. Windows, room/area dimensions & square feet may vary due to location within building. Furniture not included. E. & O. E.

ONE BED + DEN

CRAVATTE

548 SQ.FT. • 40 SQ.FT. BALCONY • 147 SQ.FT. TERRACE

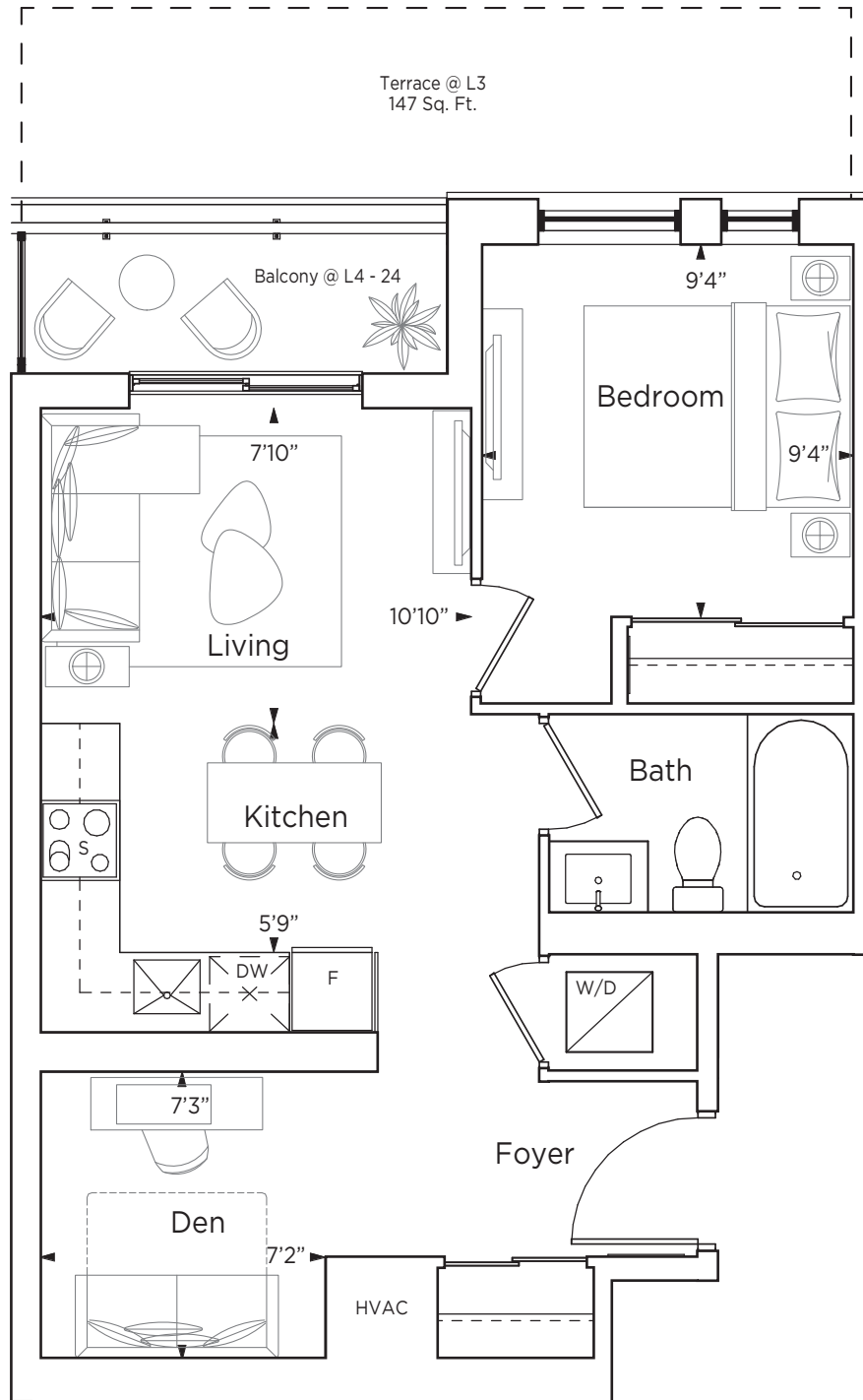

C23

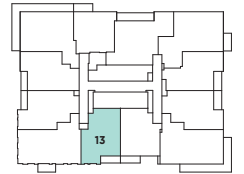

Tower B
LEVEL 15 - 24

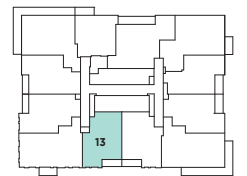

Tower B
LEVEL 9 - 14

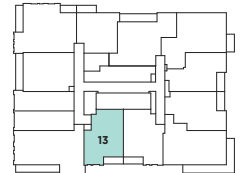

Tower B
LEVEL 7 - 8

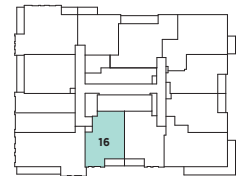

Tower B
LEVEL 6

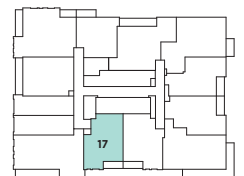

Tower B
LEVEL 5

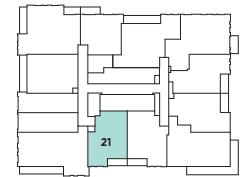

Tower B
LEVEL 4

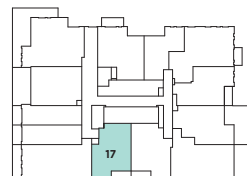

Tower B
LEVEL 3



Vincent
CONDOMINIUMS



ONE BED + DEN (BARRIER-FREE)

ESPRESSO

565 SQ.FT. • 40 SQ.FT. BALCONY

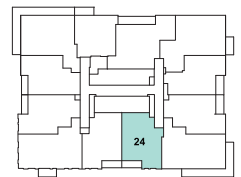
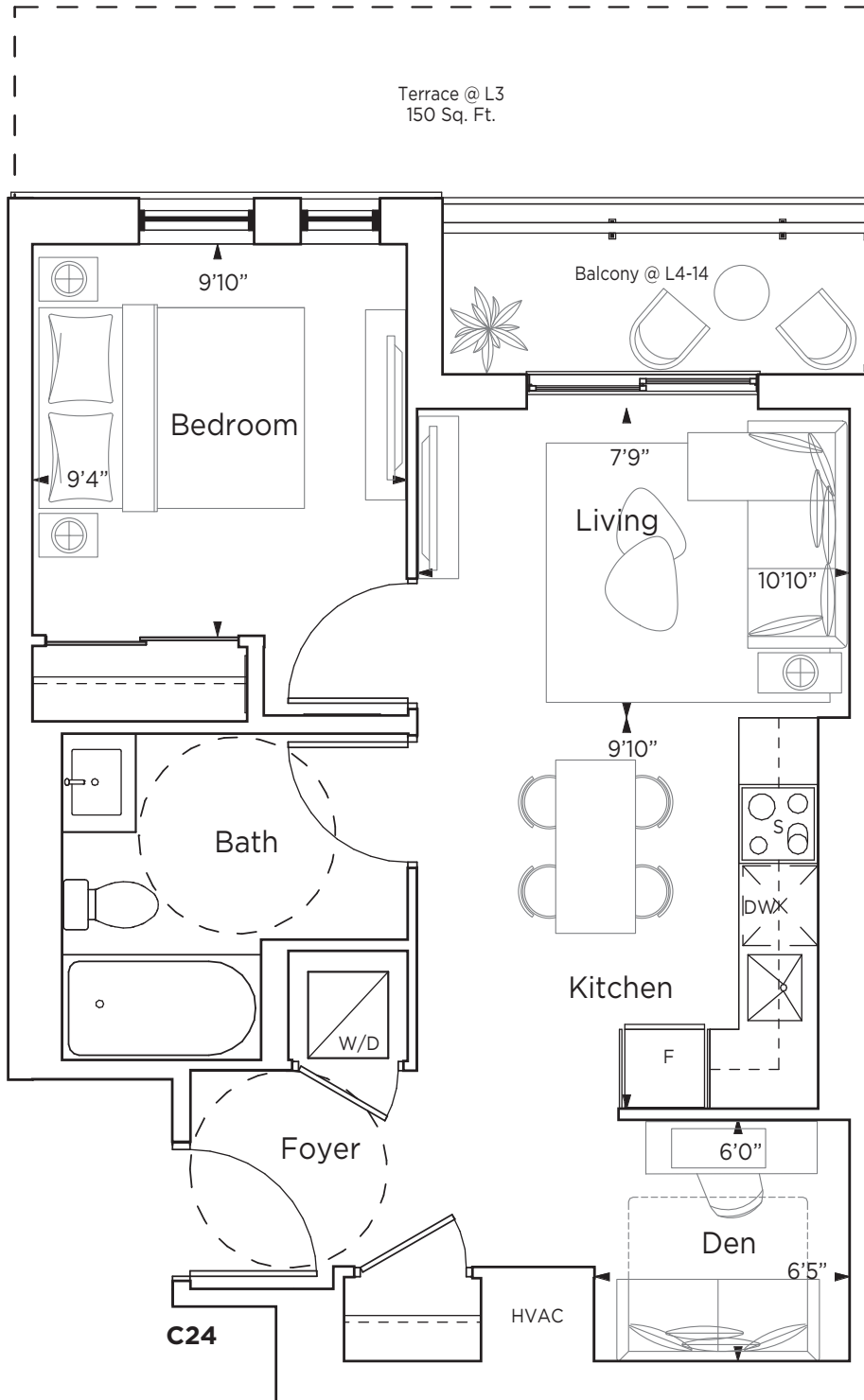

Tower B
LEVEL 9 - 14

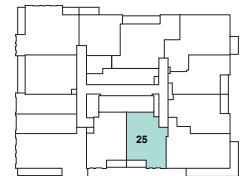

Tower B
LEVEL 7 - 8

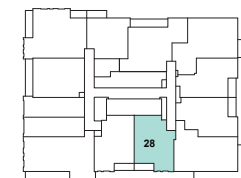

Tower B
LEVEL 6

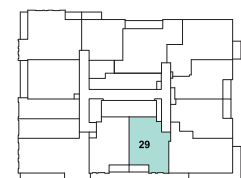

Tower B
LEVEL 5

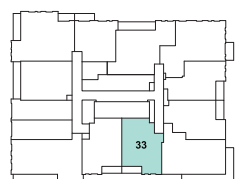

Tower B
LEVEL 4

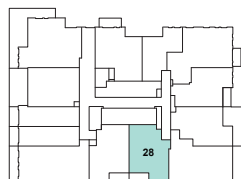

Tower B
LEVEL 3



Vincent
CONDOMINIUMS



Materials, specifications and floor plans are subject to change. All renderings are artist's concept. All floor plans are approximate dimensions. Actual usable floor space may vary from stated floor area. Balcony/terrace areas may vary. Windows, room/area dimensions & square feet may vary due to location within building. Furniture not included. E. & O. E.

TWO BED

ROME

776 SQ.FT. • 94 SQ.FT. BALCONIES

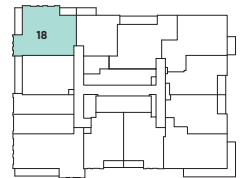
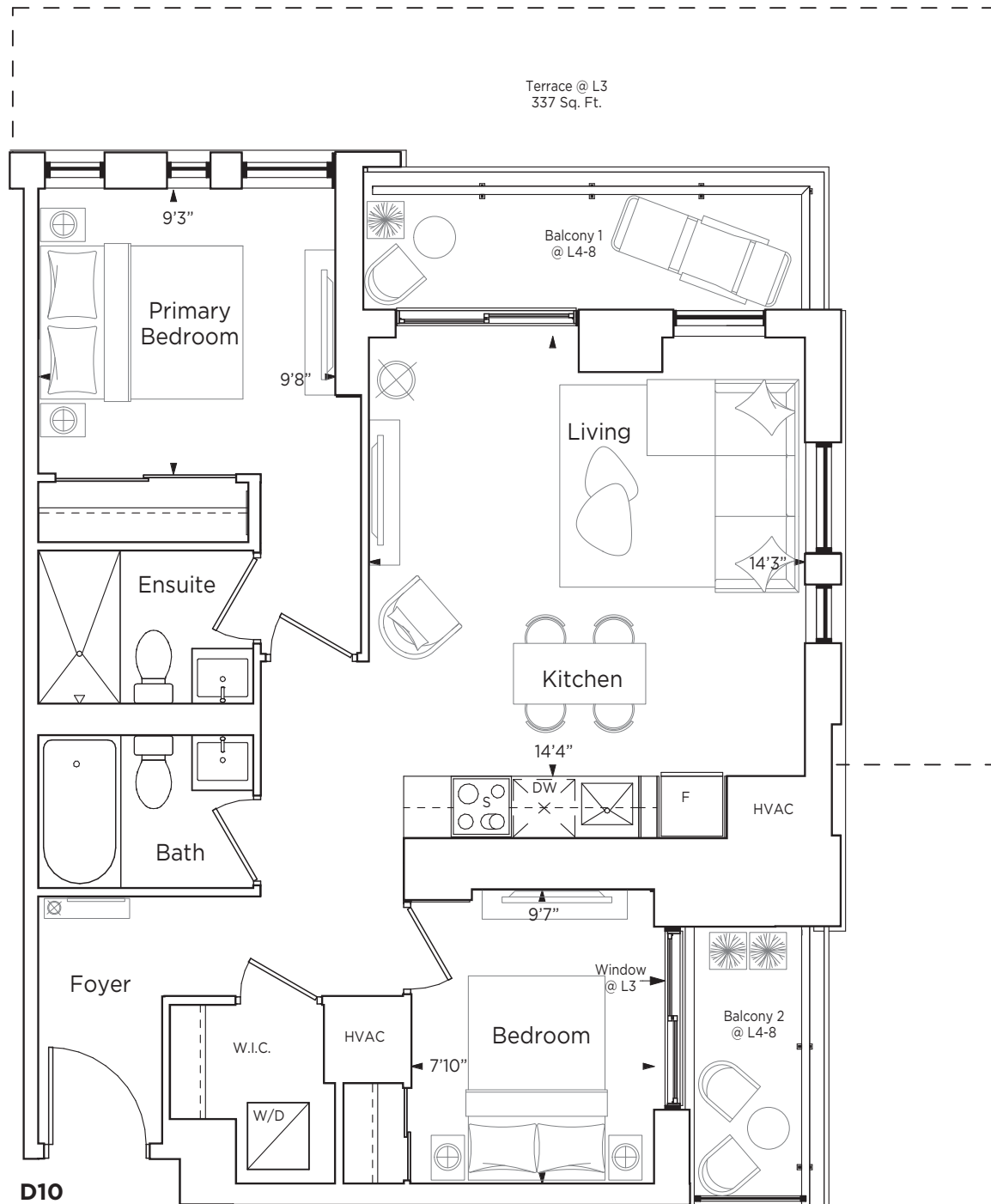

Tower B
LEVEL 7 - 8

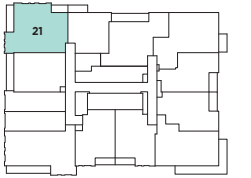

Tower B
LEVEL 6

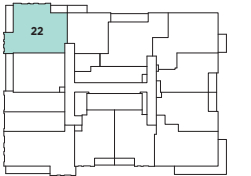

Tower B
LEVEL 5

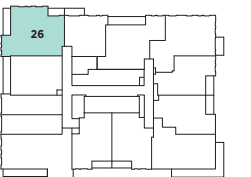

Tower B
LEVEL 4

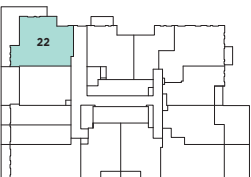

Tower B
LEVEL 3



Vincent
CONDOMINIUMS



Materials, specifications and floor plans are subject to change. All renderings are artist's concept. All floor plans are approximate dimensions. Actual usable floor space may vary from stated floor area. Balcony/terrace areas may vary. Windows, room/area dimensions & square feet may vary due to location within building. Furniture not included. E. & O. E.

TWO BED (BARRIER-FREE)

PARIS

747 SQ.FT. • 42 SQ.FT. BALCONY

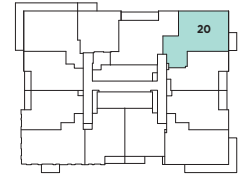
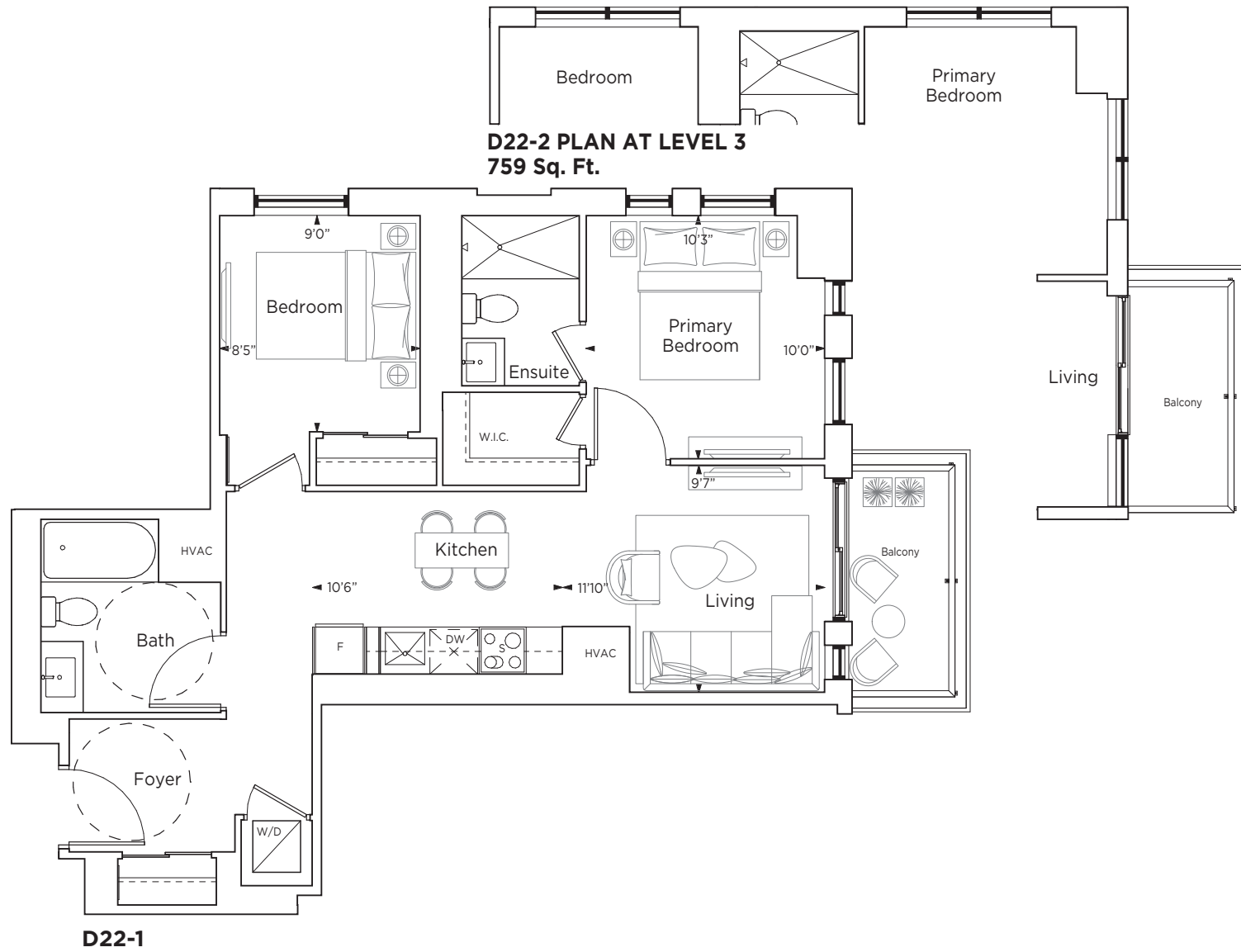

Tower B
LEVEL 15 - 24

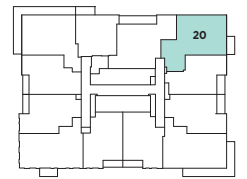

Tower B
LEVEL 9 - 14

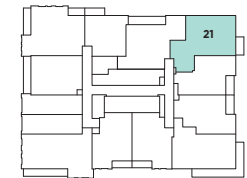

Tower B
LEVEL 7 - 8

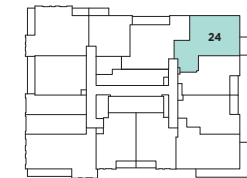

Tower B
LEVEL 6

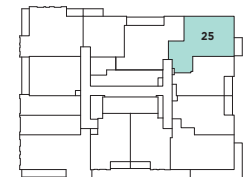

Tower B
LEVEL 5

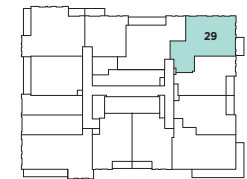

Tower B
LEVEL 4

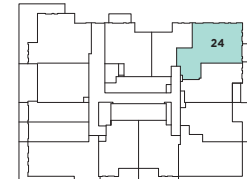

Tower B
LEVEL 3



TWO BED

MARTINI

706 SQ.FT. • 88 SQ.FT. BALCONIES

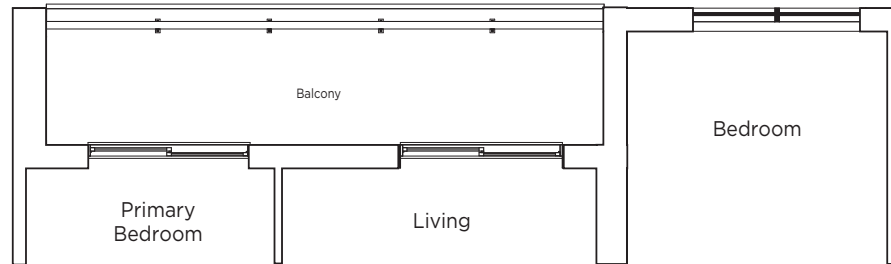

PLAN AT LEVEL 5 - 24

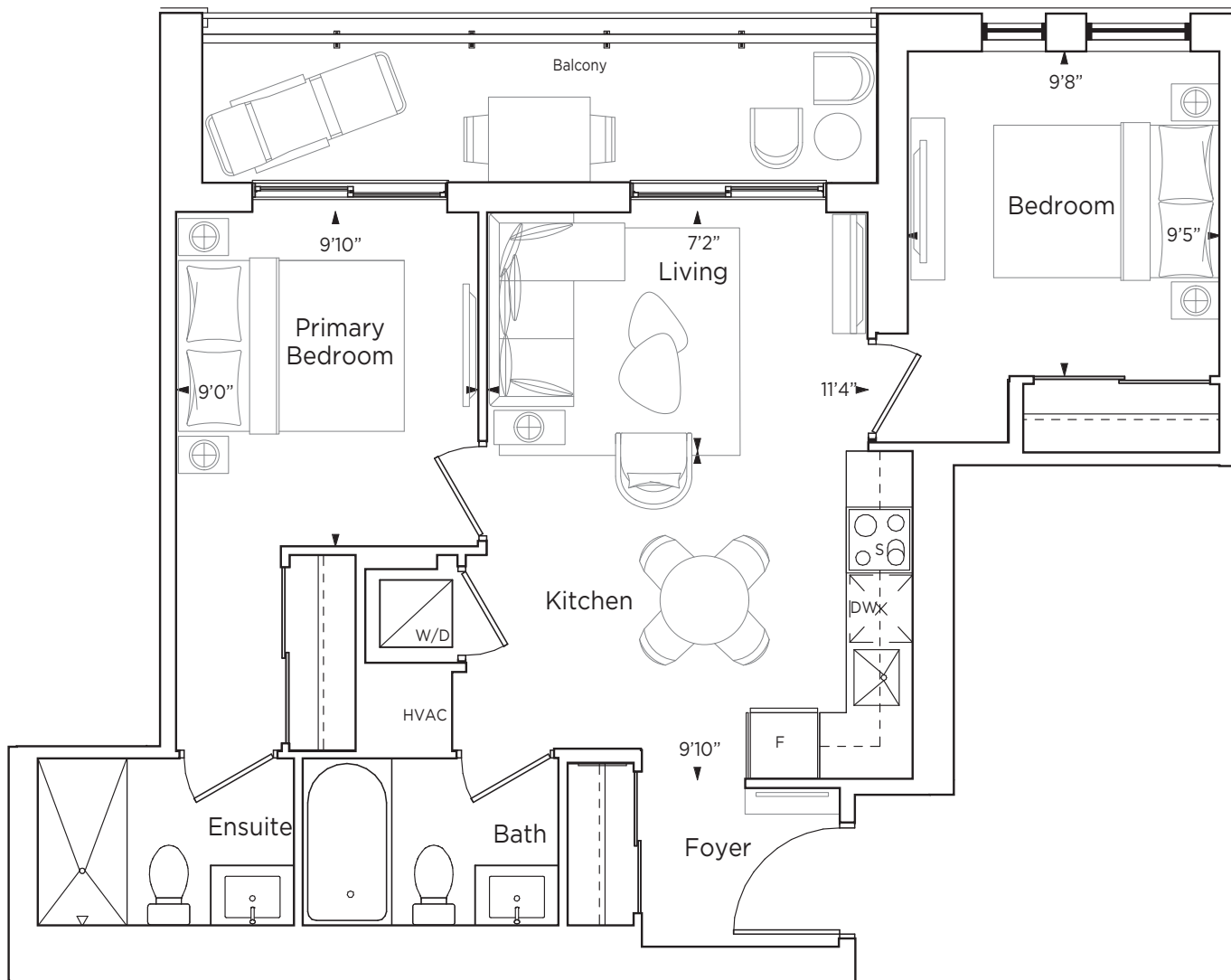

D23

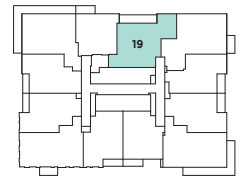

Tower B LEVEL 15 - 24

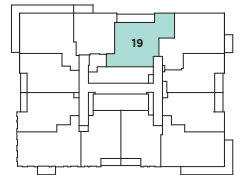

Tower B LEVEL 9 - 14

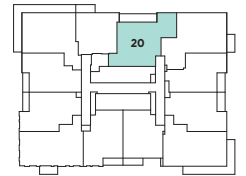

Tower B LEVEL 7 - 8

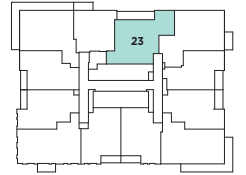

Tower B LEVEL 6

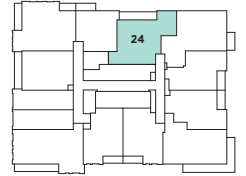

Tower B LEVEL 5

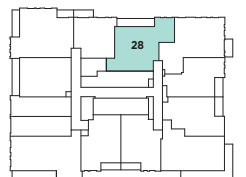

Tower B LEVEL 4



Vincent
CONDOMINIUMS



Materials, specifications and floor plans are subject to change. All renderings are artist's concept. All floor plans are approximate dimensions. Actual usable floor space may vary from stated floor area. Balcony/terrace areas may vary. Windows, room/area dimensions & square feet may vary due to location within building. Furniture not included. E. & O. E.

ONE BED

BUCKINGHAM

469 SQ.FT. • 42 SQ.FT. BALCONY

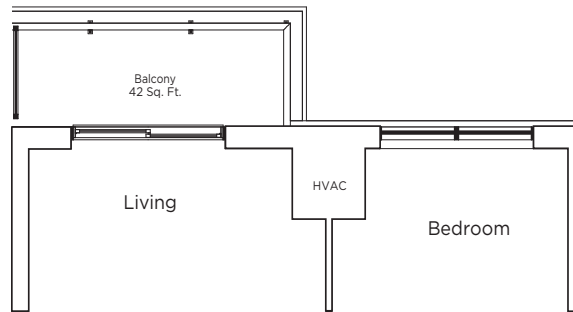

PLAN AT LEVEL 5 - 8

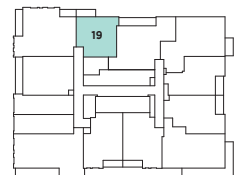
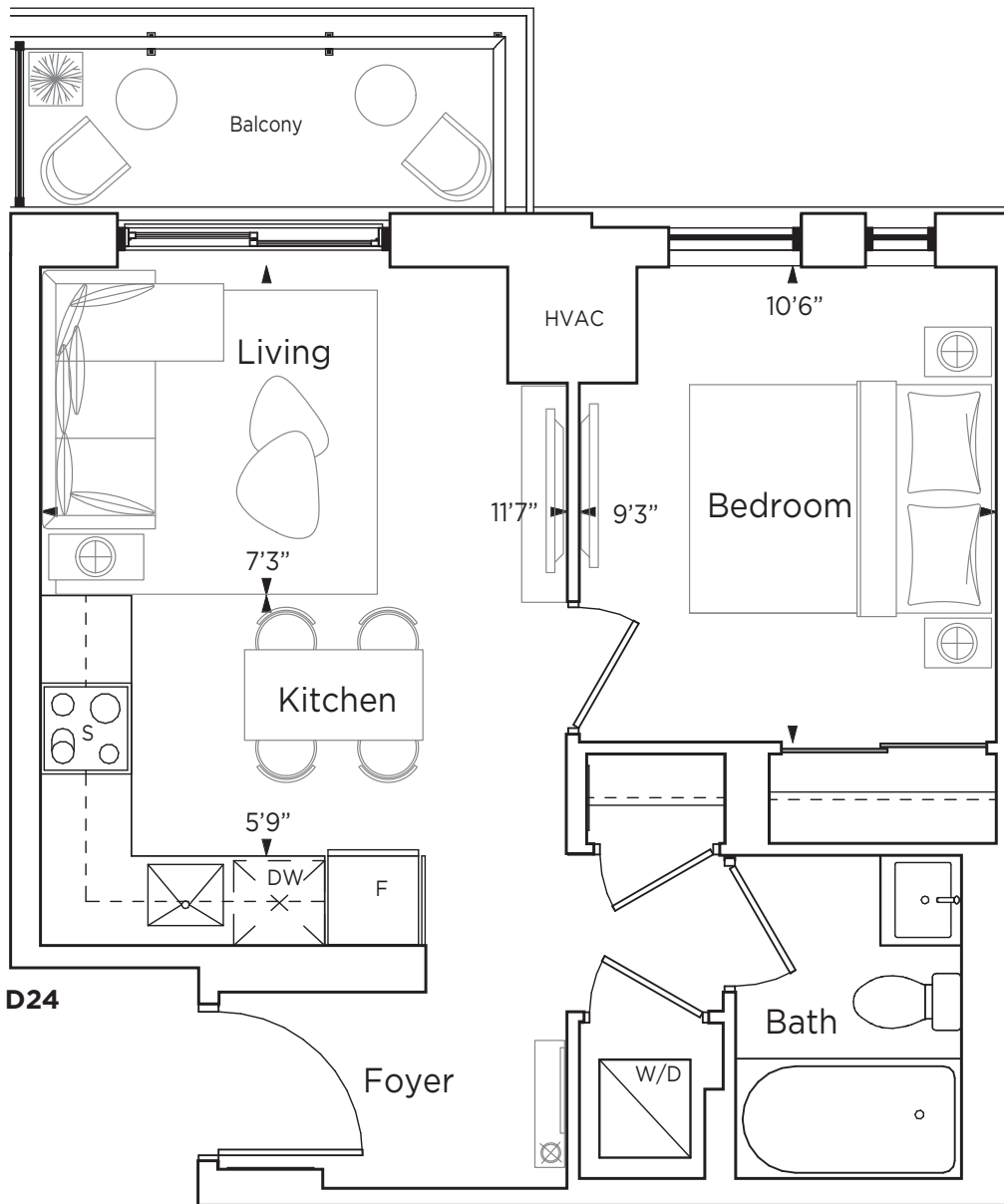

Tower B
LEVEL 7 - 8

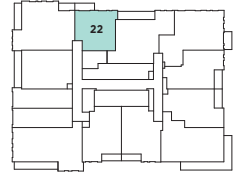

Tower B
LEVEL 6

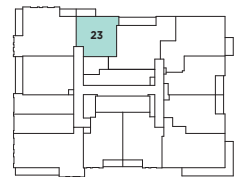

Tower B
LEVEL 5

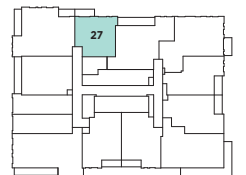

Tower B
LEVEL 4



Vincent
CONDOMINIUMS



ONE BED

CASHMERE

486 SQ.FT. • 45 SQ.FT. BALCONY

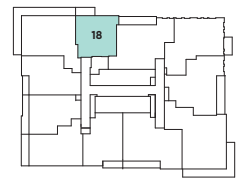
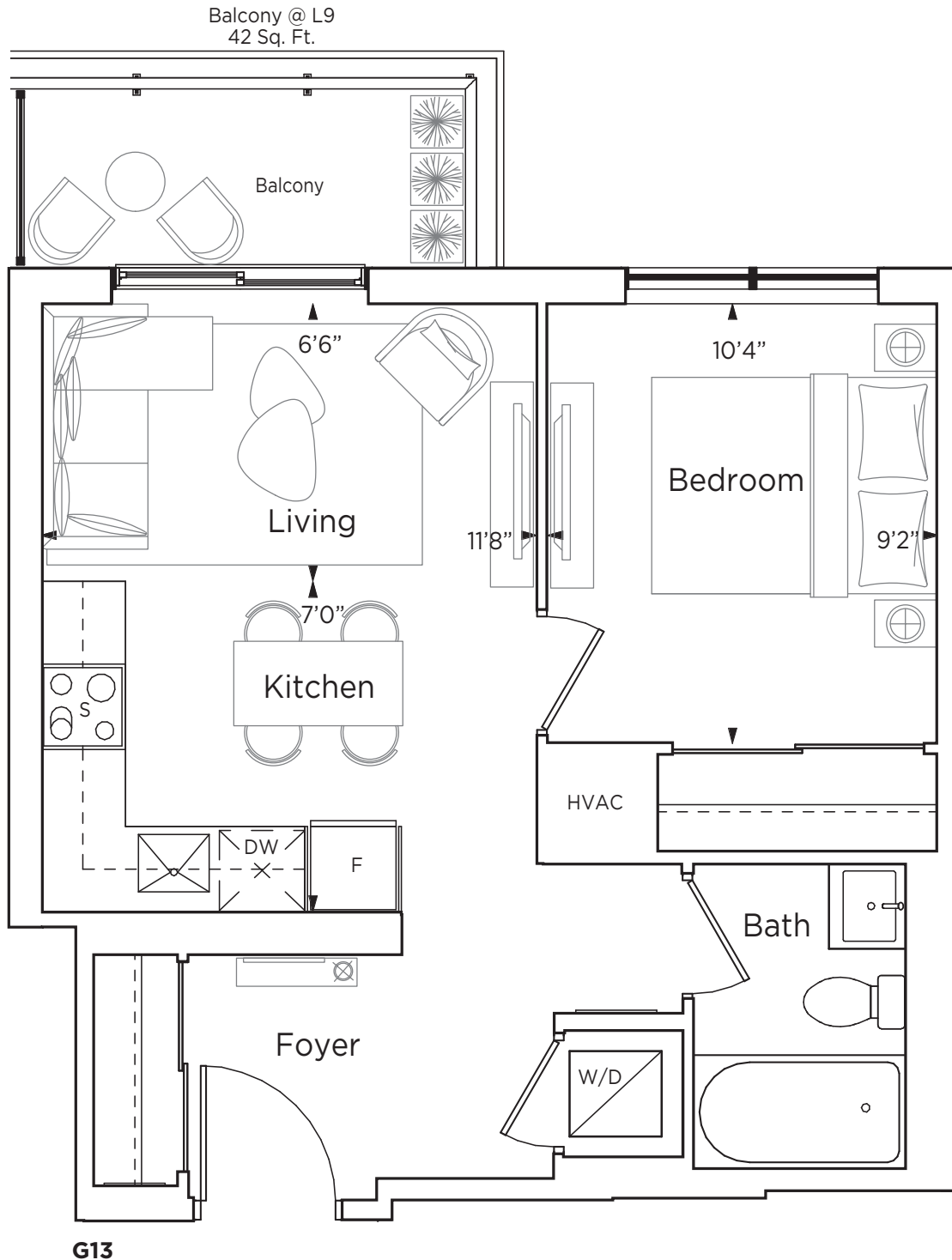

Tower B
LEVEL 25 - 27

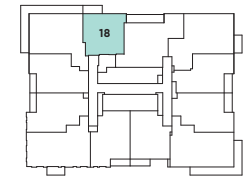

Tower B
LEVEL 15 - 24

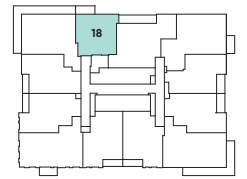

Tower B
LEVEL 10-14

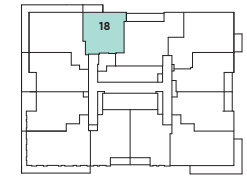

Tower B
LEVEL 9



Vincent
CONDOMINIUMS



ONE BED + DEN

COUTURE

535 SQ.FT. • 45 SQ.FT. BALCONY

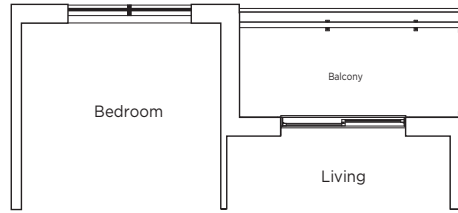

PLAN AT LEVEL 5 - 24
530 Sq. Ft.

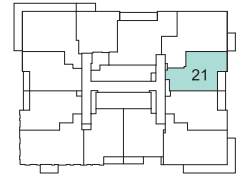
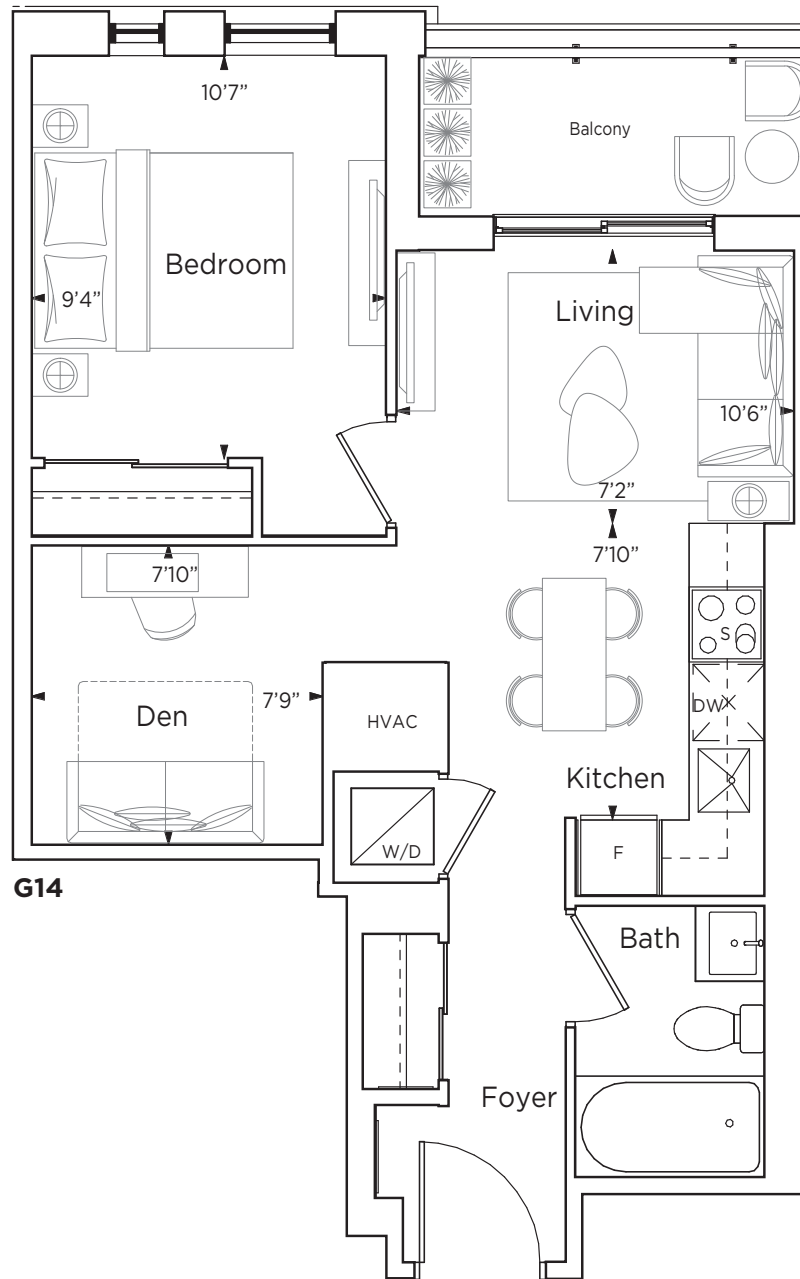

Tower B
LEVEL 15 - 24

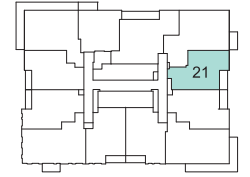

Tower B
LEVEL 9 - 14

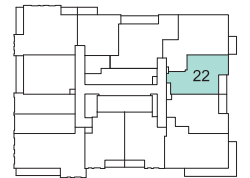

Tower B
LEVEL 7 - 8

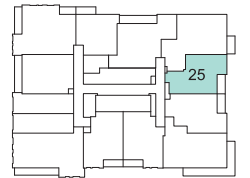

Tower B
LEVEL 6

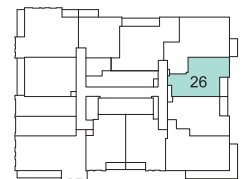

Tower B
LEVEL 5

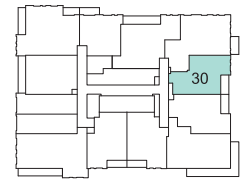

Tower B
LEVEL 4

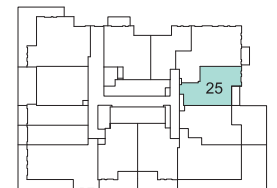

Tower B
LEVEL 3



Vincent
CONDOMINIUMS



ONE BED (BARRIER-FREE)

CHEVRON

518 SQ.FT. • 40 SQ.FT. BALCONY

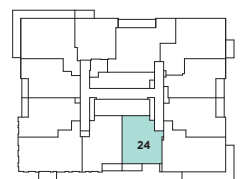
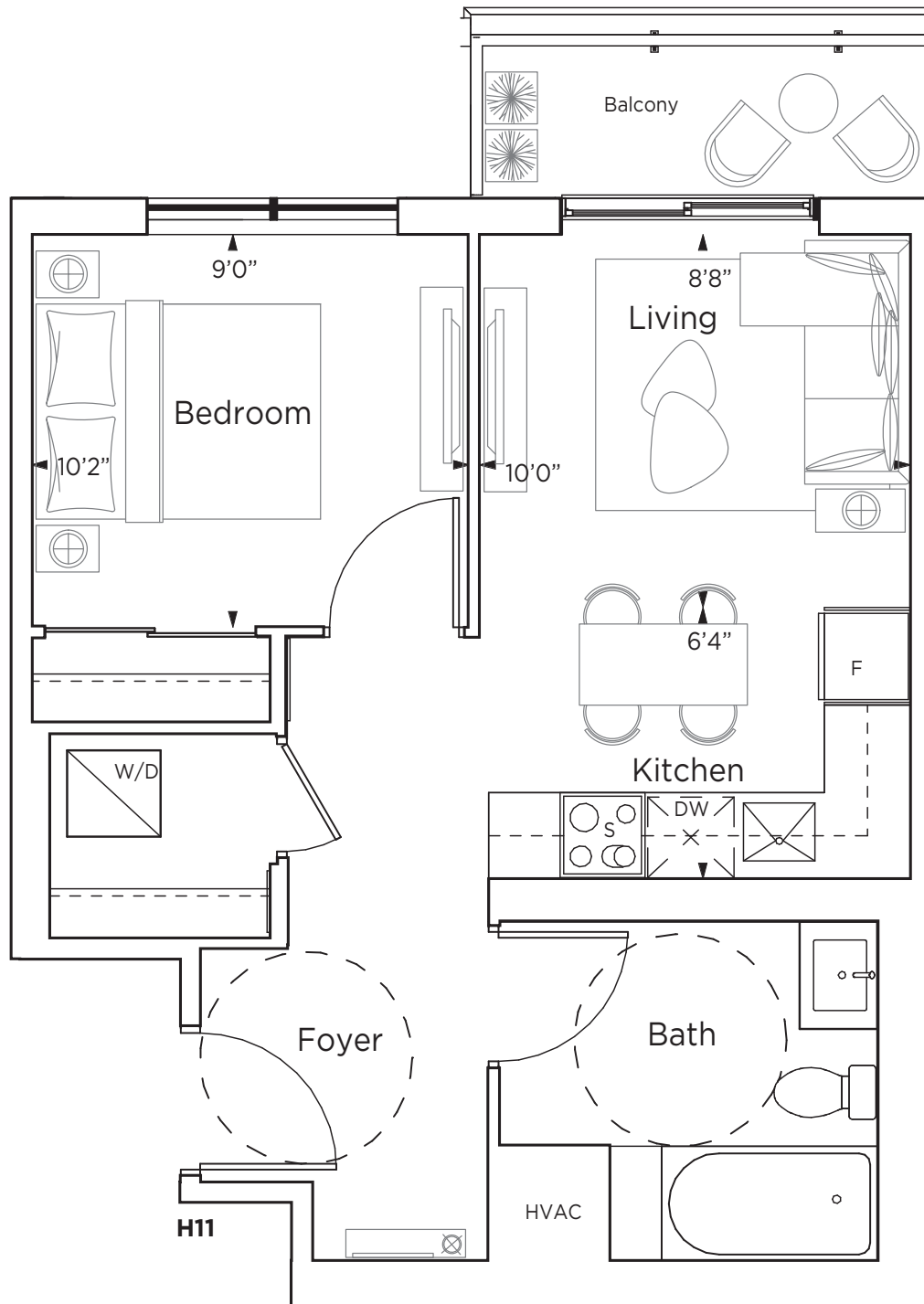

Tower B
LEVEL 15 - 24

ONE BED

CASINO

507 SQ.FT. • 72 SQ.FT. BALCONY

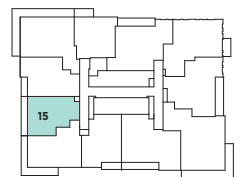
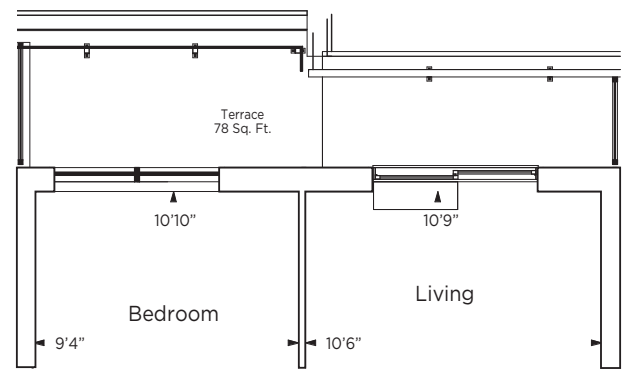
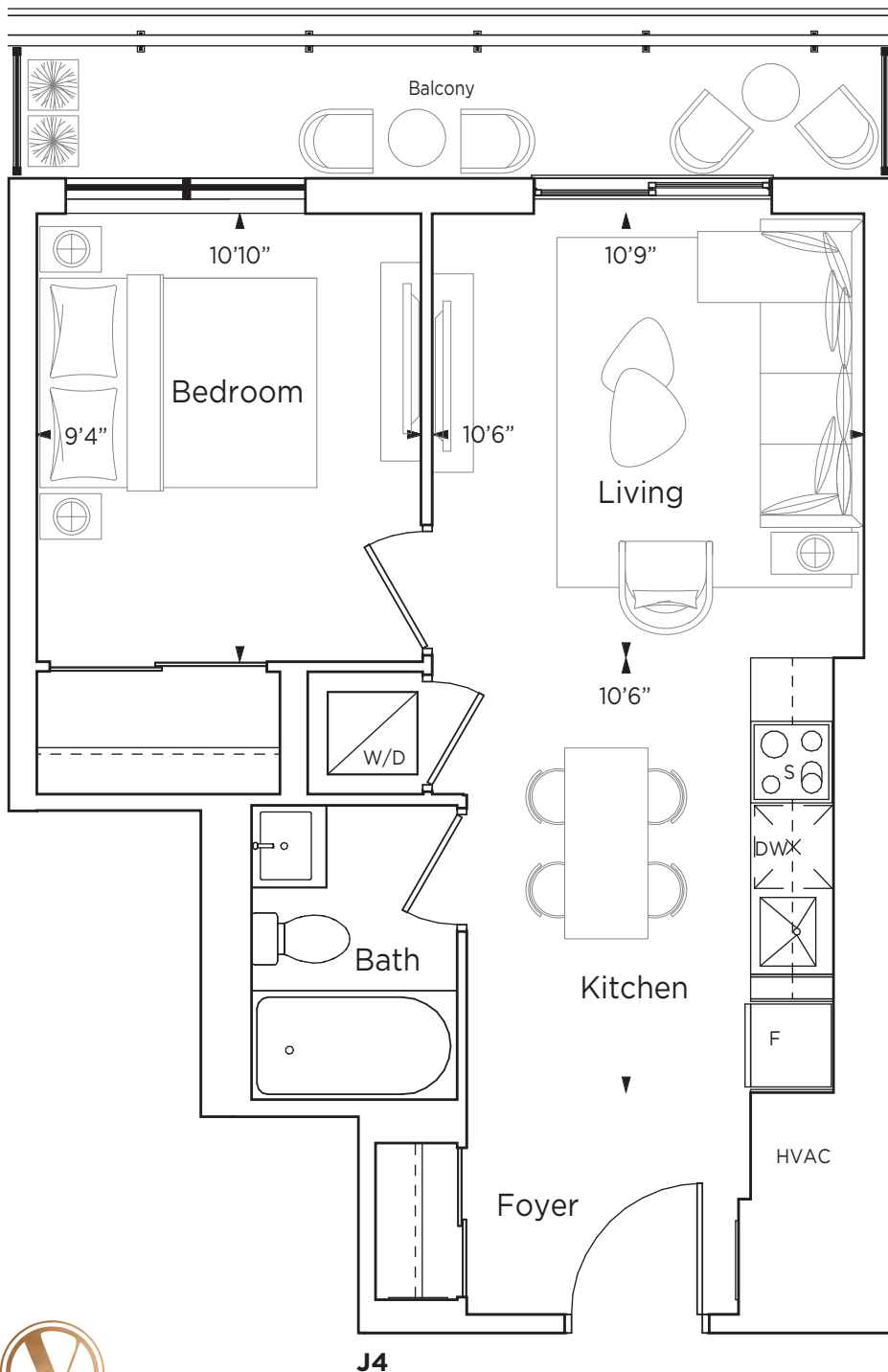

**Tower B
LEVEL 26 27**

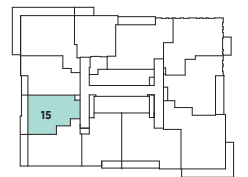

**Tower B
LEVEL 25**



Vincent
CONDOMINIUMS



Materials, specifications and floor plans are subject to change. All renderings are artist's concept. All floor plans are approximate dimensions. Actual usable floor space may vary from stated floor area. Balcony/terrace areas may vary. Windows, room/area dimensions & square feet may vary due to location within building. Furniture not included. E. & O. E.

ONE BED

ETON

570 SQ.FT. • 69 SQ.FT. TERRACE

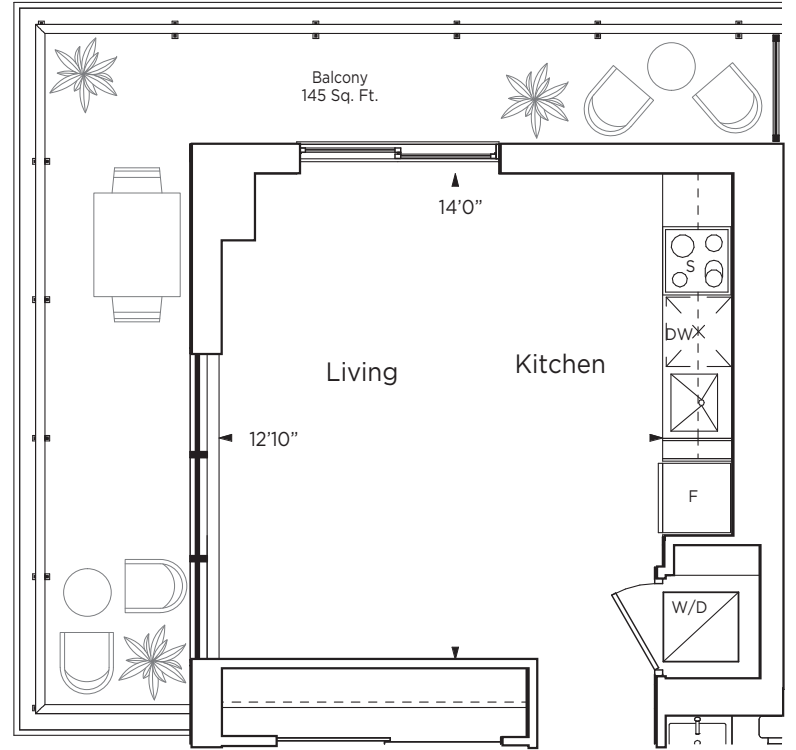
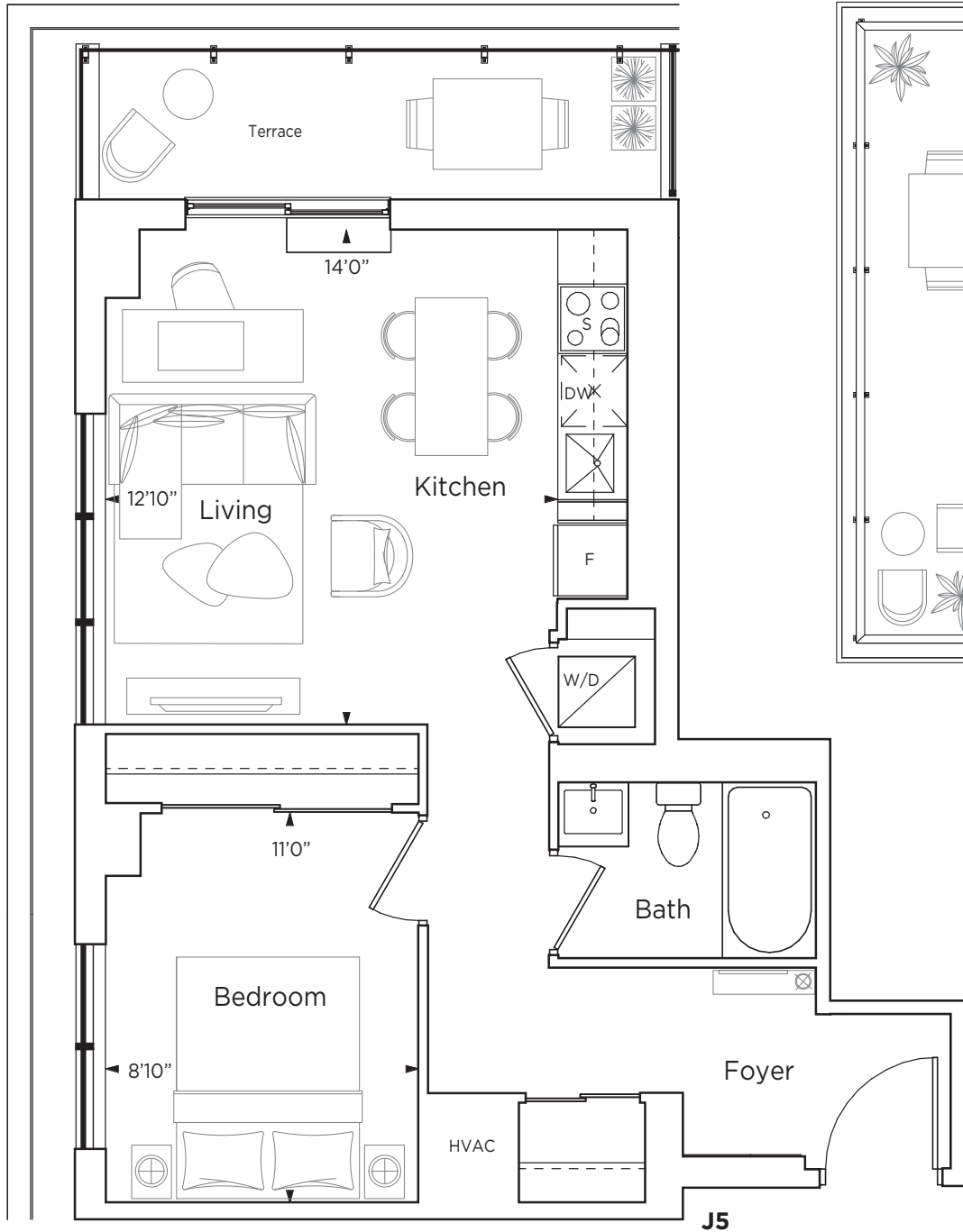

BALCONY PLAN AT LEVEL 26 - 27

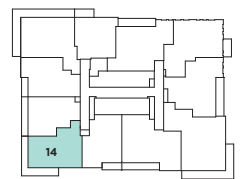

**Tower B
LEVEL 26 - 27**

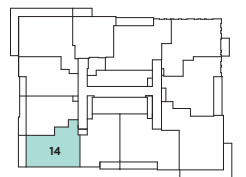

**Tower B
LEVEL 25**



Vincent
CONDOMINIUMS



Materials, specifications and floor plans are subject to change. All renderings are artist's concept. All floor plans are approximate dimensions. Actual usable floor space may vary from stated floor area. Balcony/terrace areas may vary. Windows, room/area dimensions & square feet may vary due to location within building. Furniture not included. E. & O. E.

ONE BED + DEN

CONTINENTAL

530 SQ.FT. • 40 SQ.FT. BALCONY

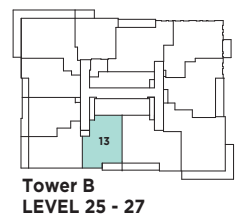
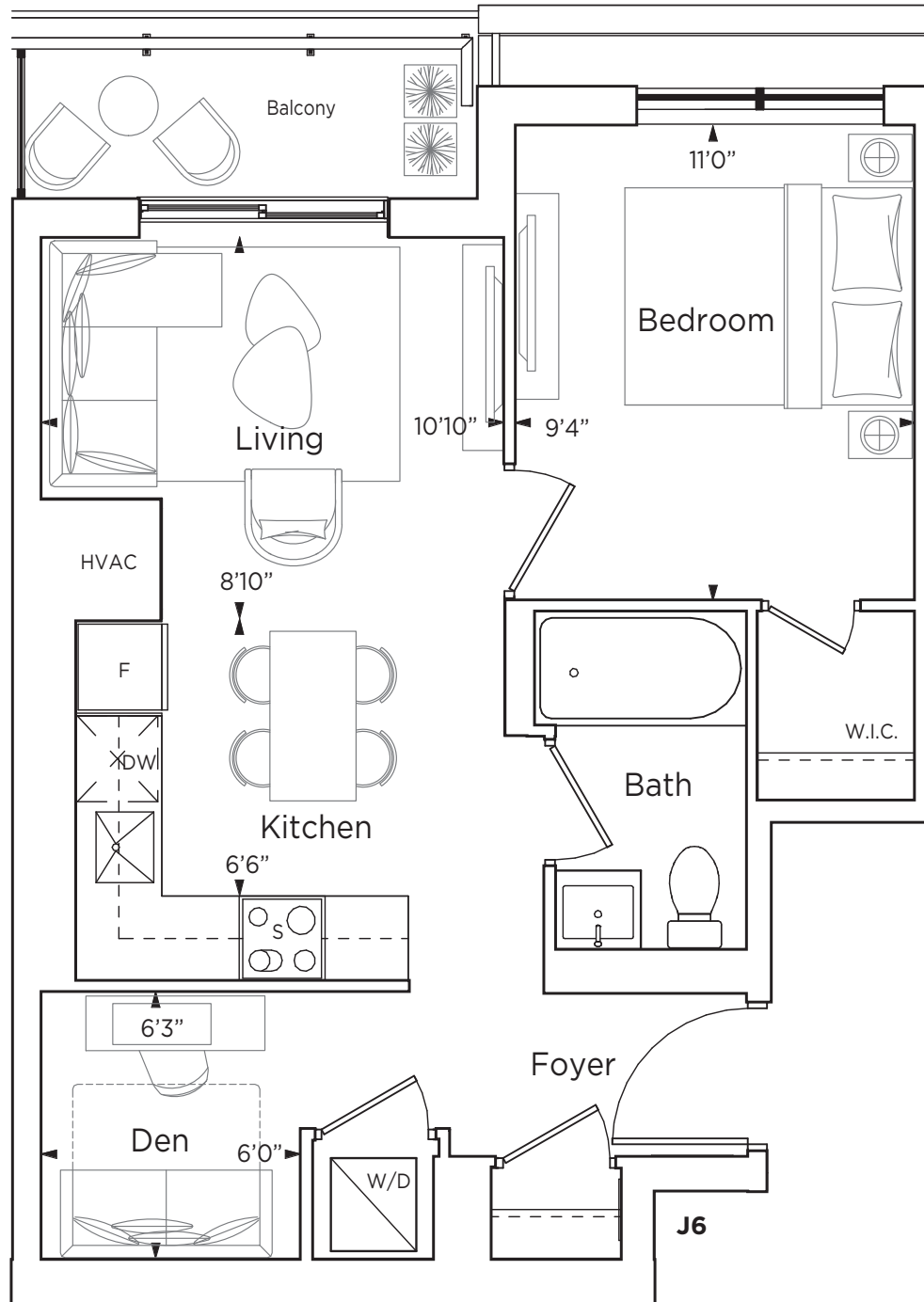

Materials, specifications and floor plans are subject to change. All renderings are artist's concept. All floor plans are approximate dimensions. Actual usable floor space may vary from stated floor area. Balcony/terrace areas may vary. Windows, room/area dimensions & square feet may vary due to location within building. Furniture not included. E. & O. E.

TWO BED

MOSCOW

743 SQ.FT. • 75 SQ.FT. BALCONY

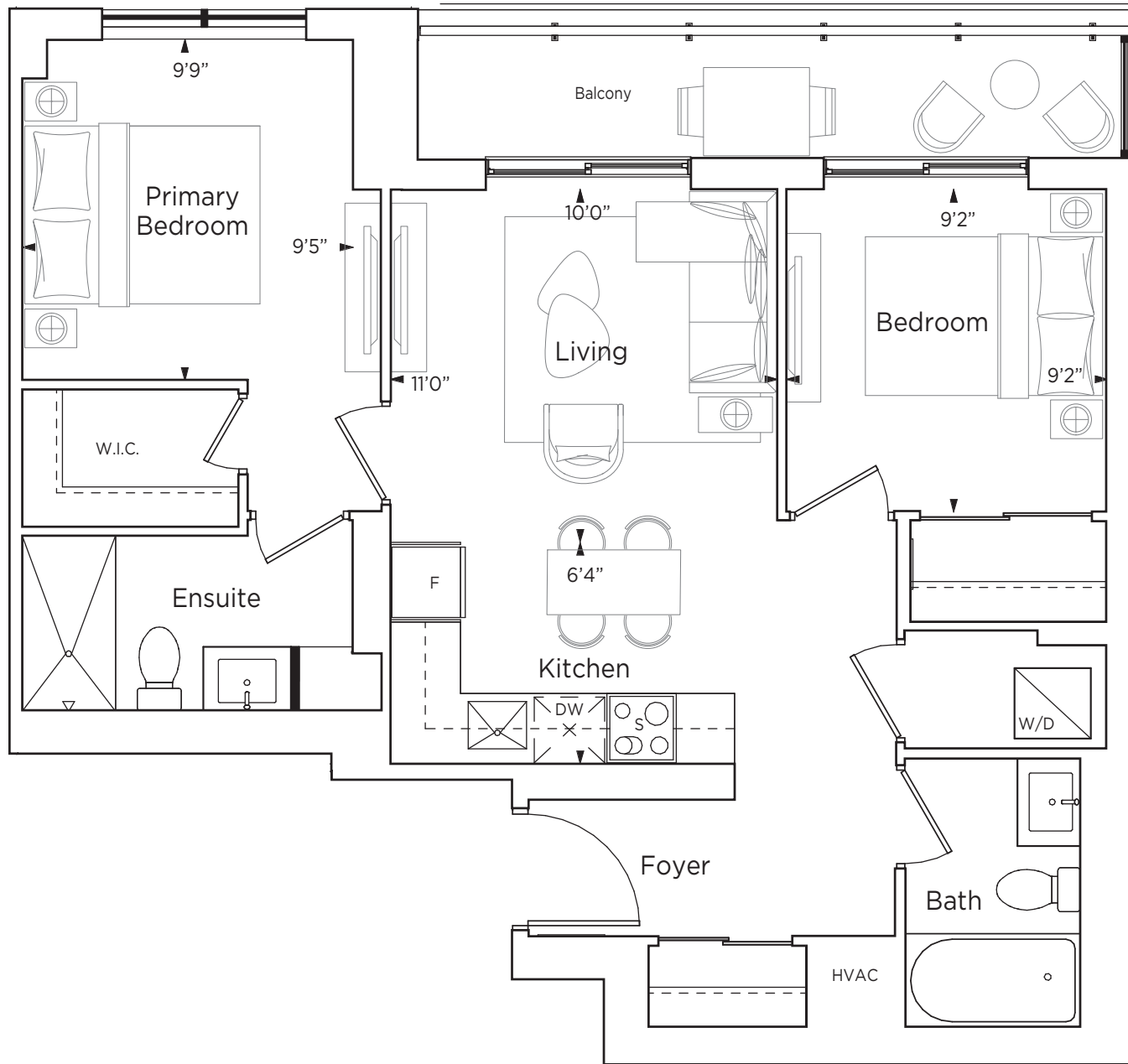

J7

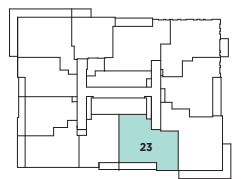

Tower B
LEVEL 25 - 27

Materials, specifications and floor plans are subject to change. All renderings are artist's concept. All floor plans are approximate dimensions. Actual usable floor space may vary from stated floor area. Balcony/terrace areas may vary. Windows, room/area dimensions & square feet may vary due to location within building. Furniture not included. E. & O. E.

TWO BED (BARRIER-FREE)

TANGIER

850 SQ.FT. • 185 SQ.FT. BALCONY



Vincent
CONDOMINIUMS

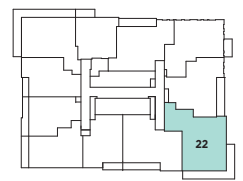

Tower B
LEVEL 25 - 27

Materials, specifications and floor plans are subject to change. All renderings are artist's concept. All floor plans are approximate dimensions. Actual usable floor space may vary from stated floor area. Balcony/terrace areas may vary. Windows, room/area dimensions & square feet may vary due to location within building. Furniture not included. E. & O. E.

TWO BED

MANHATTAN

704 SQ.FT. • 91 SQ.FT. BALCONY

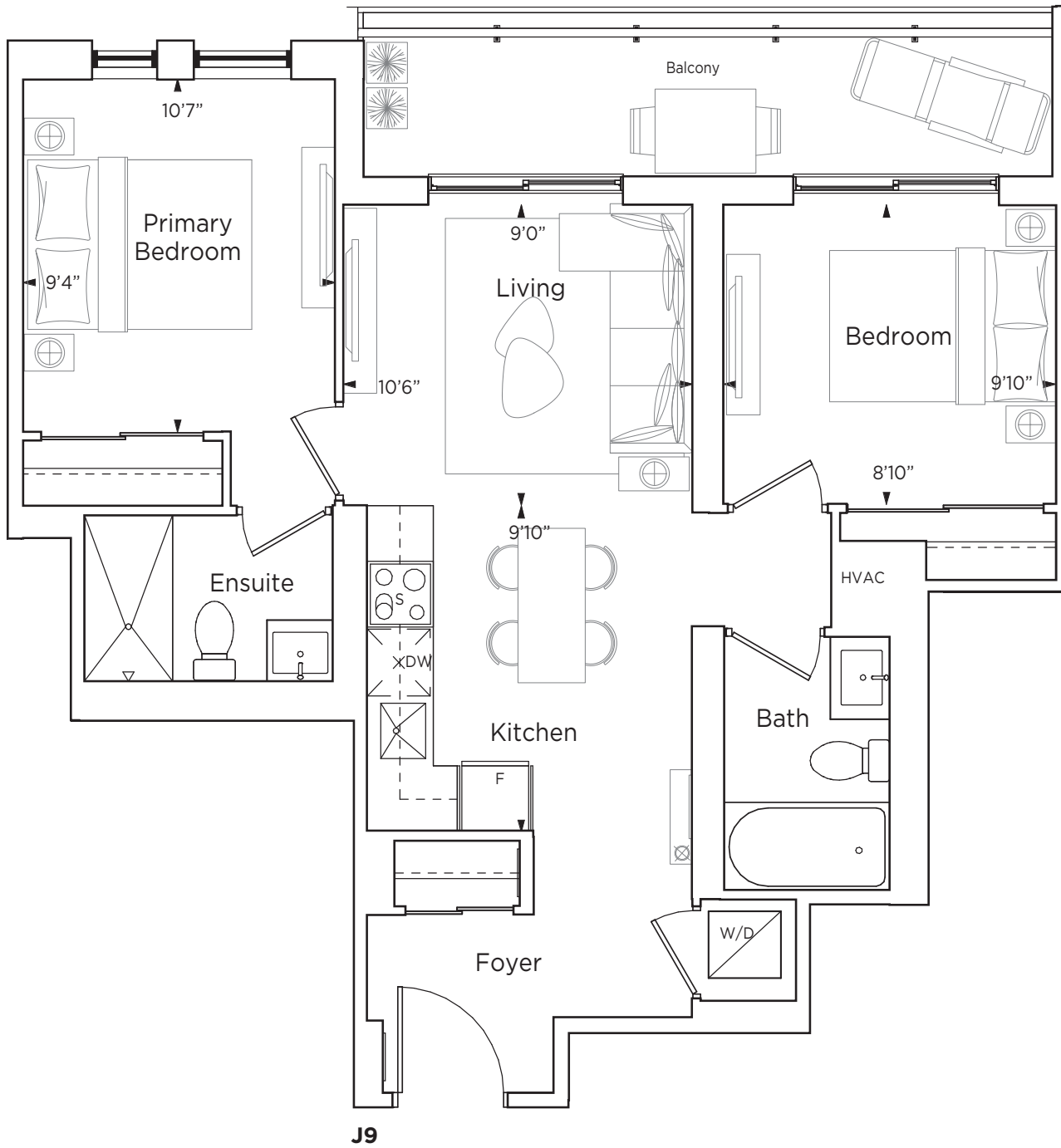

Vincent
CONDOMINIUMS

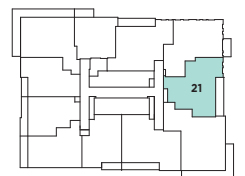

Tower B
LEVEL 25 - 27

Materials, specifications and floor plans are subject to change. All renderings are artist's concept. All floor plans are approximate dimensions. Actual usable floor space may vary from stated floor area. Balcony/terrace areas may vary. Windows, room/area dimensions & square feet may vary due to location within building. Furniture not included. E. & O. E.

TWO BED

MARSALA

705 SQ.FT. • 43 SQ.FT. BALCONY

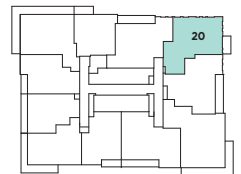
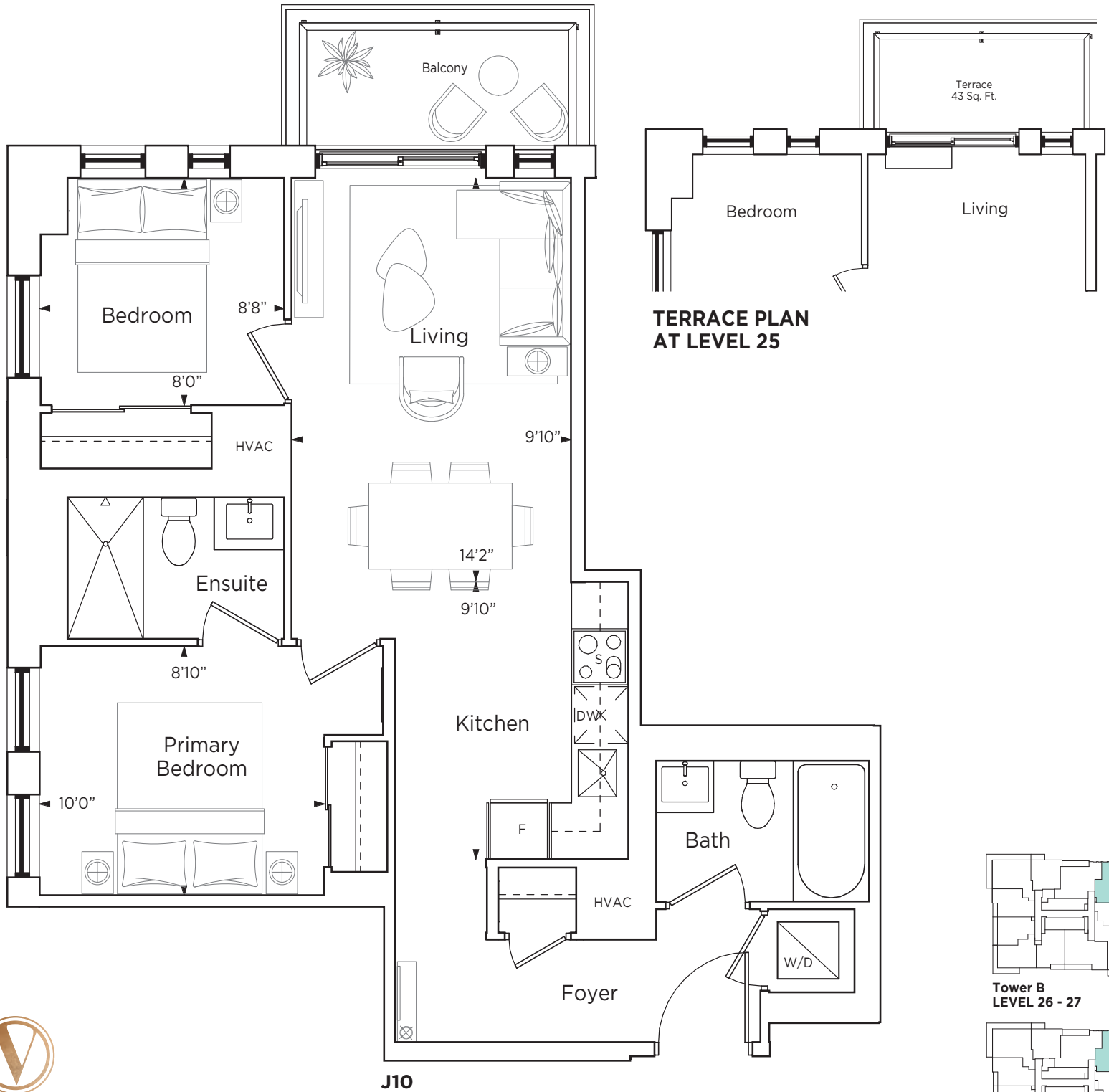

Tower B
LEVEL 26 - 27

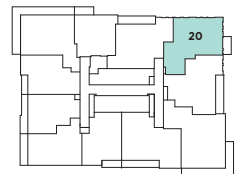

Tower B
LEVEL 25



Vincent
CONDOMINIUMS



Materials, specifications and floor plans are subject to change. All renderings are artist's concept. All floor plans are approximate dimensions. Actual usable floor space may vary from stated floor area. Balcony/terrace areas may vary. Windows, room/area dimensions & square feet may vary due to location within building. Furniture not included. E. & O. E.

TWO BED

MADRID

704 SQ.FT. • 88 SQ.FT. BALCONY

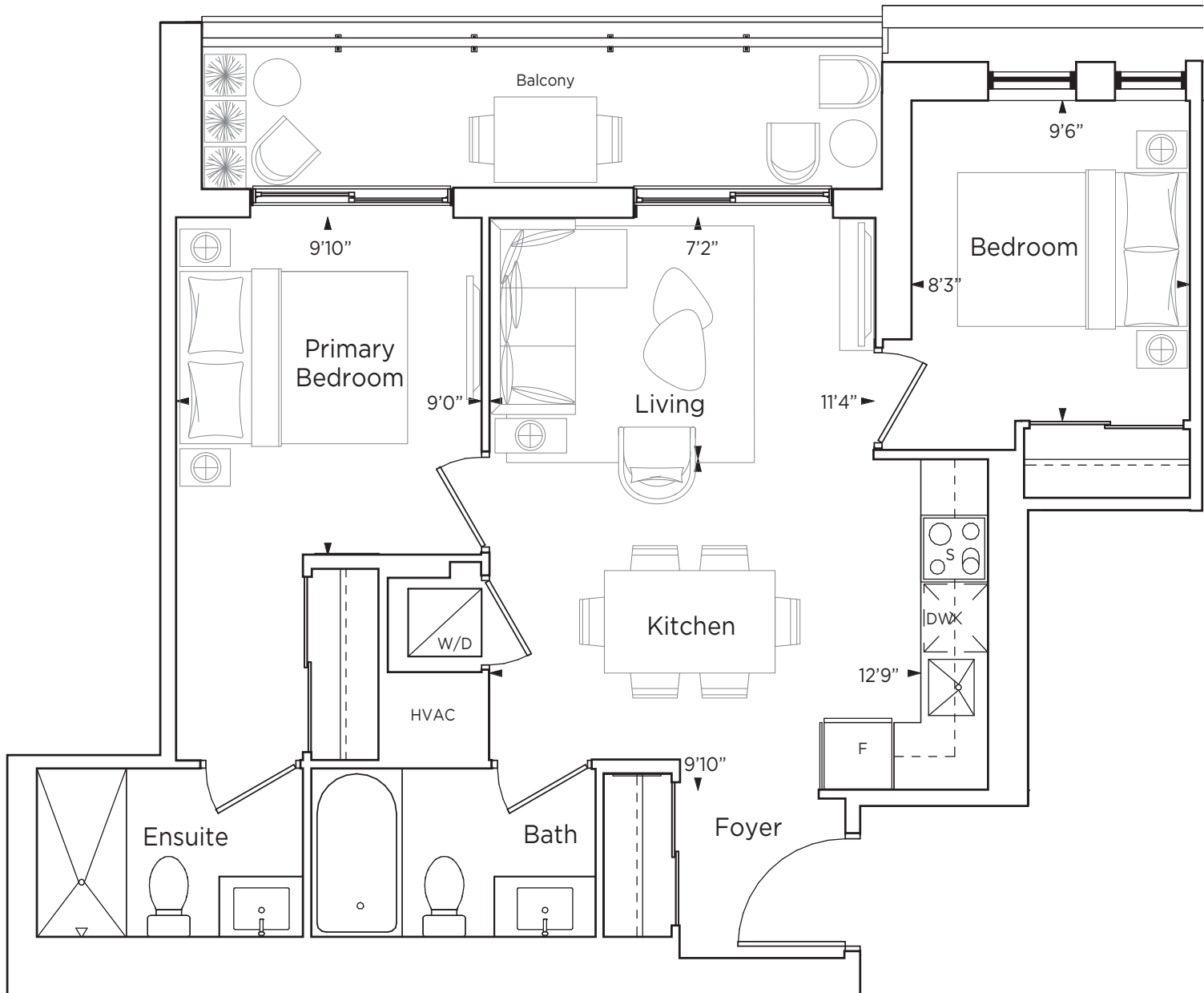

J11



Vincent
CONDOMINIUMS

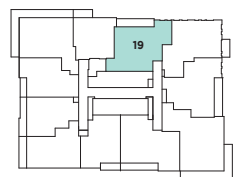

Tower B
LEVEL 25 - 27

Materials, specifications and floor plans are subject to change. All renderings are artist's concept. All floor plans are approximate dimensions. Actual usable floor space may vary from stated floor area. Balcony/terrace areas may vary. Windows, room/area dimensions & square feet may vary due to location within building. Furniture not included. E. & O. E.